

# AUSTRALIAN **Target** RIFLE®

The Official Magazine of the National Rifle Association of Australia Limited

July /August 2017

Issue No 129

**Aust Team  
results NZ  
and Sth Africa**

**Paul Savage  
Wins SARA  
Queens**

**Success for Corbett  
in VRA Queens**

**\$7.50**

Print Post Approved  
No. 326705/00010  
ISSN 1832-3944



# WANT TO BE THE BEST ? USE THE BEST! Gehmann

SUPPLYING WINNERS  
WORLD WIDE SINCE  
1949



**568MC** rearsight iris, 48-colour and polarisation filter set



**566-S** rearsight iris, 6-colour filter



**565** rearsight iris, 6-colour filter, two polarisation filters



**568** rearsight iris, 12-colour filter, two polarisation filters



**566-R** rearsight iris, 6-colour filter



**540** 'Champion' see-through rearsight



**520** iris foresight



**522-S** iris foresight



**844** multi-height sight base set



**437** 'pulse-free' sling



**466** half-cover glove



**Forbes Wholesale Pty. Ltd.**

P.O. Box 589  
ELTHAM 3095  
Victoria, Australia

A.B.N. 91 006 005 465  
A.C.N. 006 005 465

Web: [www.forbesws.com.au](http://www.forbesws.com.au)  
Email: [forbes@forbesws.com.au](mailto:forbes@forbesws.com.au)  
Phone: (03) 9439 6111

# AUSTRALIAN Target RIFLE®

The Official Magazine of the National Rifle Association of Australia Limited

*"To promote and develop the sport of target shooting in Australia"*



## NATIONAL RIFLE ASSOCIATION OF AUSTRALIA LIMITED

ABN 91 373 541 259

Postal address: P O Box 414, Carina, Qld. 4152.  
Office: Belmont Shooting Complex, 1485 Old Cleveland Rd, Belmont, Qld. 4153.  
Ph: (07) 3398 1228 Fax: (07) 3398 3515.  
Email: executive@nraa.com.au Website: www.nraa.com.au  
President: Major General John Hartley (Ret'd) AO.  
Chairman: Gordon Duncan  
Executive Officer: Catherine Berry

### MEMBERS

#### AUSTRALIAN CAPITAL TERRITORY FULL BORE TARGET RIFLE ABN 1773 5450 434

Postal address: P O Box 31, Canberra City, ACT 2601.  
Website: www.canberrarifclub.org.au Email: info@canberrarifclub.org.au  
Chairman: David McIntosh 0428 943 689

#### NEW SOUTH WALES RIFLE ASSOCIATION INCORPORATED ABN 13 773189 568

Postal address: P O Box 386, Maroubra, NSW 2035. Ph: (02) 9661 4532. Fax (02) 9661 6042  
Email: info@nswra.org.au Website: www.nswra.org.au  
Executive Officer: David McGuigan, President: Dennis McCamley, Chairman: John Baxter.

#### NORTHERN TERRITORY RIFLE ASSOCIATION INCORPORATED ABN 73 135 991 210

Postal address: P O Box 406, Darwin, NT 0801. Ph/Fax: (08) 8947 1713. A.H. (08) 8945 2622  
Email: mail@ntra.org.au www.ntra.org.au  
Secretary/Treasurer: Frank Baldwin. President/Treasurer: Jeff Chaffey

#### NORTH QUEENSLAND RIFLE ASSOCIATION INCORPORATED ABN 84 883 207 560

Postal address: PO Box 918, Ravenshoe, Qld. 4888. Email: nqraoffice@gmail.com  
Ph: (07) 4097 7741. Fax: 07 4097 6293 www.nqra.org.au  
Administration Officer, Betta Gianasi President: Robert J Kennedy, Chairman: Bruce Scott

#### QUEENSLAND RIFLE ASSOCIATION INCORPORATED ABN 13 367 165237

Postal address: P O Box 38, Carina, Qld. 4152. Office: Belmont Shooting Complex,  
1485 Old Cleveland Road, Belmont, Qld. 4153. Ph: (07) 3398 4309. Fax: (07) 3395 2777.  
Email: qra@qldrifle.com Website: www.qldrifle.com  
Executive Officer: Peter Doig, President: Rodney Prayle.

#### SOUTH AUSTRALIAN RIFLE ASSOCIATION INCORPORATED ABN 40 238054 053

Office & postal address: Cnr West Terrace & North Terrace, Wingfield, S.A. 5013.  
Ph: (08) 8244 5533. Fax (08) 8244 5633. Email: admin@riflesa.asn.au Website: www.riflesa.asn.au  
Executive Officer: Paul Gale, Chairman: Reg Cunningham.

#### TASMANIAN RIFLE ASSOCIATION INCORPORATED ABN 51 718 354985

Postal address: PO Box 132, Devonport, Tas. 7310. Ph: (03) 6424 2217.  
Mobile: 0437 940 648. Email: tasrifle@primus.com.au www.tasrifle.org.au  
Secretary: Andrew Cowlrick, President: Gilbert Walker, Chairman: John Collis.

#### VICTORIAN RIFLE ASSOCIATION INCORPORATED ABN 37 5718681 51

Postal address: PO Box 5078 Sandhurst East Vic 3550.  
Office: 1 Rifle Range Rd Wellsford Vic 3551 Phone: (03) 54493153 Fax: (03) 54493954  
Email: vra@vra.asn.au Website: www.vra.asn.au  
Executive Officer: Brett Thurtell Chairman: Garry Kay.

#### WEST AUSTRALIAN RIFLE ASSOCIATION INCORPORATED ABN 38 425252 091

Postal address: P O Box 1559, Wangara W.A. 6065  
Office: Unit 1, 23 Creative Street, Wangara W.A. 6947 Ph: 08 9302 6255 Fax: 08 9302 6866.  
Email: admin@wara.asn.au. Executive Officer: Sarah Hoglin, President: Michael Farrell,  
Chairman: Allan Dods. Website: www.wara.asn.au

The NRAA is proudly supported by the

**Australian Sports  
Commission**

## South Australian Queens

See page 12



## Victorian Queens

See page 21



### Contents

Chairman's Message	3
Membership	4
<b>Features</b>	
The Australian Team Report	7
South Australian Queens	12
F Class Teams	18
Victorian Queens	21
Connected to the grid	27
Target deathwish	28
<b>Area Reports</b>	
Victoria	30
Western Australia	36
South Australia	42
Queensland	44
<b>Regulars</b>	
Obituary	51
Shooting Around	52

# INFORMATION

## PUBLISHER:

The *Australian Target Rifle* is published bi-monthly by the National Rifle Association of Australia Limited.

Views expressed by contributors are not necessarily those of the Editor, the Publisher or Member Associations.

Contents of *Australian Target Rifle* are not subject to copyright, unless specified by individual authors, and may be reproduced, by any means, in the interests and betterment of the sport but please give recognition to *Australian Target Rifle* and the author.

## ENQUIRIES:

All correspondence in respect to *Australian Target Rifle* editorial matters should be directed to:

**Daniel Cotterill**     **Laurelle Tunks**  
**Editor**                     **Deputy Editor**  
*Australian Target Rifle*  
 PO Box 399  
 Mawson ACT 2607  
**atr\_editorial@nraa.com.au**  
 Ph: 0413 287 469 (During business hours)

## SUBSCRIPTIONS:

A PDF copy of each edition of ATR magazine will be available from the NRAA website. [www.nraa.com.au](http://www.nraa.com.au)

# ISSUE DEADLINES

The deadlines for  
acceptance of copy  
for the next two issues are

(ATR 130) **July 14**

September/October 2017

(ATR 131) **September 15**

November/December 2017

## COMMERCIAL ADVERTISING.

All enquiries in respect to advertising should be directed to the Editor.

### Commercial Advertising Rates.

**Black and white:** \$400 per page or any direct proportion thereof according to size with a minimum of \$40 for 1/10 page or smaller. GST included.

A 10% discount is applicable to pre-paid full 12 month orders.

**Full Colour:** \$1000 per page.

### CLUB AND ASSOCIATION ADVERTISING:

**By virtue of recent NRAA Council discussions and a Board decision there will be no further free advertising for clubs and associations from ATR #55 onwards.**

**Advertising rates will be \$300 per B&W page or part thereof, ie, \$150 per half page and \$50 per one sixth page. GST Included.**

**Payment must accompany the ad material otherwise the advertisement will not be run. The NRAA will NOT invoice you.**

**CLASSIFIEDS:** For rates see the Classified section.

**Make all cheques/mail orders payable to:**

**NATIONAL RIFLE ASSOCIATION OF AUSTRALIA.**

**Note:** Advertisements and technical articles in the *Australian Target Rifle* are published as submitted by advertisers and contributors. The publisher has not checked the veracity of their contents and accepts no responsibility for their comment.

## Change of Address

**Change of subscription address details should be sent to your club secretary and state rifle association.**

**The Editor has no mailing lists so please don't send him address information.**

**If your magazine fails to arrive contact your State Rifle Association to check they have your correct address and to claim a spare copy.**

## DEADLINE

According to the Concise Oxford Dictionary the definition of "deadline" is, "a time limit for the completion of an activity". No definition that I could find listed "deadline" as a signal to contact the editor and ask how much more time there is to submit copy or book an ad. Ed.

## Front cover

Paul Savage, winner of the South Australian Queens.

Photograph by Greg Mayfield, of The Recorder, Port Pirie, South Australia.

# Chairman's Message

Recently I mentioned that change happens and when it does it is necessary to cope with the effects. Maybe the latest event has fallen upon us from an unexpected source which will necessitate quite a change in our thinking.

One of our suppliers - Optimus projectiles - has chosen to make their product available direct from their premises rather than through the NRAA/State Association channels.

The sale of projectiles and ammunition has been the cornerstone of the finances of the target shooting operations. If that is undermined - and the NRAA is to maintain its function in parallel with State Associations - then a shift will need to be made to an increase in affiliation fees to compensate for the shortfall in revenue raised from the sale of ammunition and components. As an estimate, such fees may need to rise by \$20 per shooter. This would be offset by the supposedly lower ammunition costs.

Should we be forced down this path it is my prediction that the cost of projectiles and ammunition will rise in price as perhaps other suppliers follow the Optimus example. At present both projectiles and ammunition are purchased in large quantities, enabling a reduction in price. A similar move for an expansion in the range of propellants may have a similar untoward effect.

Rifle shooting will continue; we won't be "rooned" as Hanrahan would predict. Please be aware that after providing Optimus with a financially rewarding contract for a year, that organisation has chosen to bite the hand that feeds it. There are three major projectile suppliers especially for target rifle shooters and not all shooters purchase a projectile based on price. Performance is high on the requirements of shooters.

Recently the NRAA received an outstanding submission in relation to the encouragement and conduct of Under 25 teams from Andrew Sims. He is prepared to drive the concept, including all aspects of team shooting. In time, this may extend to F Class teams as well.

The Under 25 team that has recently returned from competition in South Africa showed its mettle by winning the Junior Australia Match at Bloemfontein.

The final elimination to enable selection of the two competitors in the Commonwealth Games in 2018 will precede the NRAA Championships. After two full series of matches the initial 30 competitors has been reduced to 10 shooters. After the two day series, the top five names will be presented to Shooting Australia for final selection purposes.

Rifle shooting remains a safe and enjoyable sport in which we can all compete. Enjoy the opportunities you have to do so at any level.

G R Duncan,  
Chairman

# DEAL DEAL DEAL

## DUE TO PURCHASE OF FULL FACTORY RUN Specifications

- 42mm Objective Lens • Fast European Focusing • Rear Parallax Focusing
- Extended Target Turrets • Positive Click Adjustment • Quarter Clicks
- Elevation up 55 MoA down 45 MoA • Windage R&L 42.5 MoA
- Multi Coated Optics

OPTIONS: 5" x 42mm Screw  
Together Sunshades

For more products and specials visit our online store 24/7

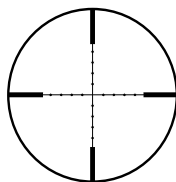

Mil-Dot



**\$ 595<sup>00</sup>**

**Free delivery Australia-wide**

### LYNX PROFESSIONAL RIFLE SCOPES

- Durable matte black finish • Excellent eye relief
- Rugged shockproof, waterproof, dustproof construction
- 30mm Monotube construction • P 16 x 42 Mil Dot Sniper Scope ideal for F Class Standard

**PO Box 846, Raymond Terrace NSW 2324**

**Phone: 02 4981 7920 Fax: 02 4981 8627**

**Website: [www.lynxoptics.com.au](http://www.lynxoptics.com.au) E-mail: [malcolmgault.lynx@bigpond.com](mailto:malcolmgault.lynx@bigpond.com)**



**LYNX OPTICS®**

*George Wittorff is a member of the Board of the NRAA, given the task of addressing membership issues facing the movement at a national level.*

*This is number seven of a series of articles aimed at achieving that goal.*

## ASAPS - Advancing Shooting as A Positive Sport

The previous six articles, spanning 12 months have tried to alert all members to the steady decline in membership, and have been aimed at State Associations and club leaders in an attempt to raise people's consciousness to the point that some positive action to attract new members and to retain them as well as existing members has taken place.

This article is a summary of previous findings, and a call to arms!

The articles began by illustrating clearly the National, and State-by-State figures for the years 2001-2016. In a couple of instances membership is heading in the right direction. In others - not so!

### Look to the Future:

If you are in a club or association that seems satisfied

with current membership trends, be aware that just relying on the hard core of members for your club to survive is not enough. If you retain 95% of members without adding new ones each year, you will have lost more than one third by year eight. If you retain 90% per year, you will have lost 30% plus by year four.

In successive articles, research findings of what works for clubs were presented, and several examples of successful programs currently being used that have proven to be successful were cited. Has your club taken up any of these ideas and given them a try?

### Develop a Positive Club Culture:

The issue of retaining members has also been looked at, again with practical suggestions for clubs to engage existing and new members. Remember, there's no point in getting people through the front door if the back door is wide open. New members drift away through lack of follow-up of visitors. How many clubs listen to new members? Does your club have a mechanism for feedback from members? Do State Associations or clubs actually evaluate how they are running? Does yours?

### Broaden Your Horizons:

Proactive clubs that offer a diverse range of disciplines are seen to be thriving. Those that sit back and wait for members to appear on the range, and then hope they come back, don't. Simple, really.

The 'good old days' of cheap ammo and cheap basic equipment have gone. The reality is that the old style shooter is being replaced with a group who are more demanding - typically one who wants to embrace one of the F Class disciplines or else are Field or Service enthusiasts.

Can your club cope with and cater for this 'new' shooter? Does it? Previous articles have advocated opening up our sport more to Field and Service enthusiasts. There are a great many of them out there - all are prospective new members. Associations and clubs need to embrace change. Try having different disciplines on alternating weeks if mid-week shooting is not viable. Think outside the box.

Remember the power of advertising and public exposure of your club's activities via the local media. Does your club have a Publicity Officer? Determine to market your club and the sport better.

### Co-operative Clubs:

You can keep your club healthy and vibrant by being



# GRENFELL

## ARMOURING SERVICES

**AGENT FOR WORLD RECORD AWARD WINNING BENCHMARK BARRELS**

I specialise in custom rifle building for Target Rifle Shooters, Sporting Shooters and Long-Range Hunters.

Stocking and manufacturing an extensive range of products and accessories, specialising in custom rifle building; custom rifle parts and glass pillar bedding; manufacture of custom tapered scope rails; V Block bedding systems; pro pod bipods; and barrel tuners.



*Australia Cup winners:  
Peter Thurtell, Jim Bailey and Ben Emms*

Benchmark Rifle barrels / including rim fire barrels, Rock Creek 5R cut rifled barrels, Defiance Benchrest Actions / varmint actions / CheyTac Long Range, Stiller Actions

**Australian Agent for:** Masterclass Stocks; Seekins Precision scope rails and Seekins Precision scope rings; and Stallings Machine Rightsights. **Supplier and stockist of:** Nightforce scopes & accessories, XLR Evolution chassis stocks, Maddco Barrels, MAB Barrels and Omark Rifle Parts, Jewell Triggers, Boyd's laminate stocks, loading dies and Leupold scope rings. Montana extreme bore solvent, Redding and Hornady products.

**CONTACT GRENFELL ARMOURING SERVICES**  
26 BELL STREET, BENDIGO, VICTORIA 3550, AUSTRALIA

BUSINESS HOURS PH: (03) 5441 3380  
INTERNATIONAL PH: 61 3 5441 3380  
MOBILE: 040 059 8905 FAX: (03) 5441 2003  
WWW.GRENFELLARMOURINGSERVICE.COM.AU

personally involved. Research shows that where job rosters operate, people are more inclined to enjoy the club's activities, take ownership and bring new members. Alternatively, if a club relies on the usual five percent of members to run the club and therefore, have to turn up to everything, it runs the real risk of them becoming disillusioned or tired out, or sick of criticism. Everyone needs to step up and take some responsibility for the running of the club. Being a participating member has enormous rewards.

Membership fees are currently due and within a few weeks the numbers will be in. Whether or not this series of articles have made any difference will be evident. Hopefully, when the next set of graphs is completed, there will be a positive result.

**Finally: a Parable.**

In the 9th Century in northern China, a heavy and valuable bronze bell sank into a river during transport. Engineers' efforts to raise it failed due to its weight. Several years later, a priest named Lu Mei Shujen sought permission to raise the bell, with the proviso that if successful the bell would reside in a local temple.

Given permission, Lu Mei Shujen instructed his assistants to cut and gather an immense number of bamboo rods. These are hollow, light and practically unsinkable. These rods were taken down to the bell by divers and one by one attached to the bell.

After many thousands of rods had been attached, the bell slowly began to shift, then move due to the accumulated buoyancy of the bamboo rods. The bell was floated, then retrieved and placed in the local temple.

The point being, that each individual rod had an imperceptible impact, but in the final scheme of things, each rod's efforts, working with the others, collectively made a difference and a positive result.

*Ref: The Practising Administrator: Vol 26 No4*

**Is Your Club Planning an Event in 2017?**

**Boost your registration numbers by advertising in ATR Magazine**

For events in September, October, November or December send your event details by July 14. We will help you put an ad together.

Contact **Laurelle** for more information  
**0413 287 469** or  
[atr\\_editorial@nraa.com.au](mailto:atr_editorial@nraa.com.au)



**The simple and cost effective solution for your club or private range**

**Key features of the Silver Mountain System**

- Easy installation and calibration
- Powered by rechargeable batteries
- Each target operates independently, or meshed
- Separate repeater creates a Wi-Fi hotspot
- BYO wireless tablets or smartphones
- Use your existing target frames
- No firing line computer/ server needed
- Very portable and easy to handle



**Why consider Silver Mountain Targets?**

- The most cost-effective solution for clubs and ranges
- Proven system, developed by shooters and used internationally
- Over 100 targets operating worldwide
- 31 targets operating at 13 ranges in New Zealand
- Canadian, US and European sales to military and shooting ranges
- Tested extensively under Australian conditions



**Want a demo at your range?  
Contact us for more information**

**Email:** [silvermountaintargets@gmail.com](mailto:silvermountaintargets@gmail.com)  
**Web:** [www.electronictargets.biz](http://www.electronictargets.biz)  
**Facebook:** Silver Mountain Targets

Copyright Silver Mountain Targets <http://www.silvermountaintargets.com/E&OE>



## HOW THE NRAA WORKS FOR YOU

### **Direct benefits from the NRAA include:**

- Provision of quality ammunition and components.
- Comprehensive insurance for all.
- Quality National magazine – now available to all members online.
- Provision of elite level competition in a formal manner through State/National/International level.
- Governance and provision for a wide range of shooting disciplines.
- Development and updating of the Standard Shooting Rules, which determine conduct of all matches, free for National members.
- Nationally endorsed training manuals.
- Support to State Associations in State/Commonwealth Government liaison etc.

### **Indirect benefits associated with NRAA membership:**

- The benefits associated with strengthening the membership base of the NRAA, and by default, the State and Territories means that all bodies gain political clout, thus reducing the view by outside bodies, such as the anti-gun lobby, as well as some Commonwealth Departments as being divided and lacking political influence.
- Current issues such as National and State Reviews of Firearms Laws and Regulations, and the change in attitude towards firearms are examples of why the NRAA is positioned to act on Associations' and shooters' behalf.
- Representation and liaison on ICFRA committees.
- Representation on various committees of Government funded bodies such as Shooting Australia.
- Membership of the NRAA is \$55.00, which costs \$1.07 a week, less than the amount spent on one factory round. This a very small price to pay to strengthen our sport, and protect our interests and enjoy the benefits of membership.



# The Australian Rifle Team in New Zealand and South Africa

Article by Darren Enslin, Photos by Donna Negus

In preparation for the tour to South Africa, the Australian Open Rifle Team travelled to Trentham, New Zealand for a test match against the Kiwis. The World Long Range Championships will be held there in 2019 and this gave the team members an opportunity to get to experience “windy” Trentham.

Australia got off to a good start at 300 yards and slowly built on the lead at every range. Australia won the New Zealand Match by 35 points for only the second time.

The Australians dominated the individual New Zealand championships. Duncan Davis won the Macefield lead up followed by Darren Enslin and Jim Bailey in third place. Our two coaches Jim and Steve went into the finals of the Ballinger Belt series 10 points ahead of the field, demonstrating their ability to pick through the very testing conditions. Jim shot a solid 75.9 in the final to win his ride in the chair and quoted his famous quip in his winner’s speech....” I’m back baby”. Steve Negus was in second place, two points behind.

In the New Zealand Championships Australia took all



Top Lady Donna Negus



Australian Team at Peter Bramley’s property

Continued from page 7



The Under 25 team

Proud supporter of Australian F Class teams to Canada 2017



Reloading Equipment and Shooting Supplies  
[qstore@qldrifle.com](mailto:qstore@qldrifle.com)

**NOW STOCKING LAB RADAR**



Discover the new generation of Ballistic Velocity Radar



[www.myLabRadar.com](http://www.myLabRadar.com)



Shop Online at:

**[www.q-store.com.au](http://www.q-store.com.au)**

or call (07) 3843 5377 to order

follow us on facebook at [www.facebook.com/TheQstore](http://www.facebook.com/TheQstore)

Australia wide shipping \*excludes restricted items



Belmont Rifle Range- 1485 Old Cleveland Rd, Belmont, Brisbane

Store Hours: 12pm - 4pm Mon - Wed 10am - 5pm Thur - Sat

three top spots: first Jim Bailey, second Steve Negus and third Duncan Davis.

Jim Bailey also won the long range aggregate, followed again by Steve. The short range aggregate was won by Geoff Grenfell followed by David Black and Matt Pozzebon.

The Open Australian Target Rifle Team and Under 25 team travelled to Bloemfontein, South Africa in March this year to compete in the Australia Match, Protea match and as individuals in the South African Championships. The Gen. De Wet range is situated approximately 5000 feet above sea level and is an open exposed range showing good mirage; with a resident Red Hartebeest and herd of Springbok that constantly interrupt the day's shooting programme. The two week event was filled with at least three individual shoots (Bisley style) and a couple of teams ranges per day and can be likened to a "shooting marathon". Great Britain (GB), the United States of America (USA) and Canada also sent teams to compete.

Individually the Australians demonstrated their talent with four trophies won outright.

Matt Pozzebon won the Dave Smith Cup, Donna Negus won the Scottish Sword and Norma Seyferdt (Top Lady) and Jim Bailey won the Long Range Aggregate.

In the State Presidents (our Queens equivalent), the GB captain Nick Tremlett won the ride in the chair to a disappointed Geoff Grenfell finishing fourth and David Black finishing seventh just a point behind but four v's more than the winner. Under 25 Chris Schwebel demonstrated his up and coming



*Matt Pozz and David Smith - Matt won the Dave Smith trophy*

talent, two points behind the winner; placing 12th.

Jim Bailey took fifth place in the Grand Aggregate and in the South African Championships we had five in the top 15: J Bailey third, G Grenfell ninth, M Pozzebon 12th, D Black 13th and S Negus 14th.

In the Open Australia Match, Great Britain went into the 900 metres with a five-point lead over Australia

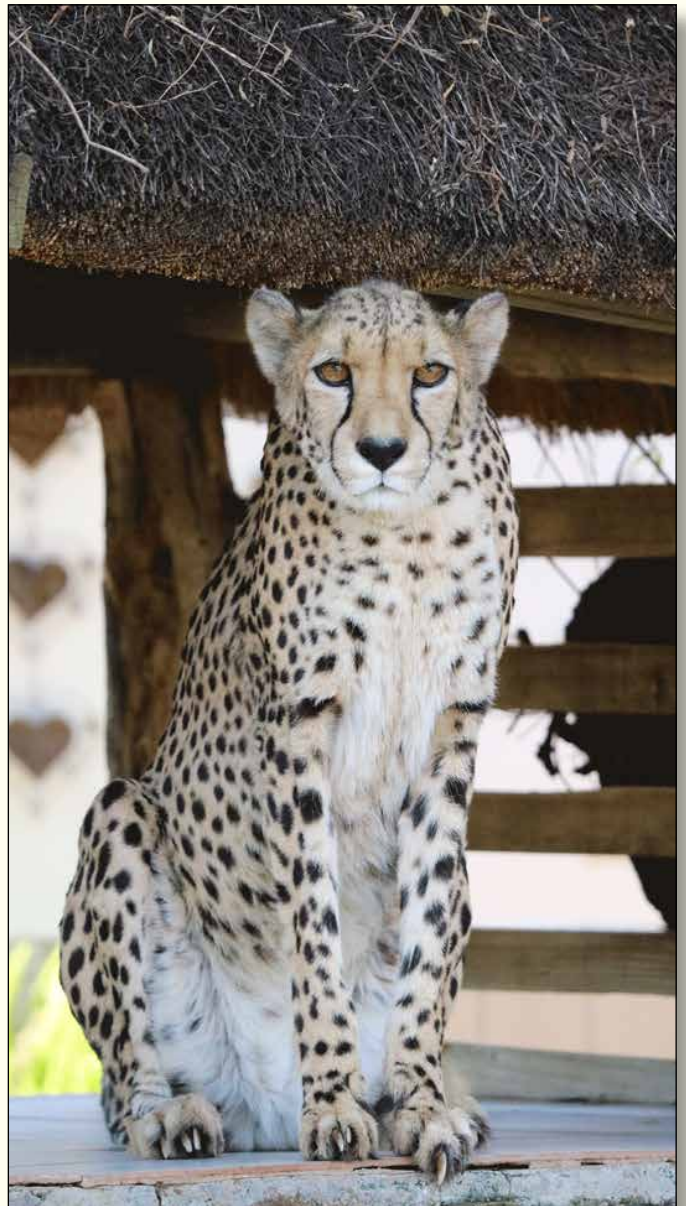

*Interesting wildlife*



*Andrew and son Nic Sims*

## one ff precision

**"Cooper Tunnels"**

**Sight and Glare Tube Package**

**Price: A\$180<sup>+GST</sup>**

**Includes:**

- 1 x Precision Sight (black)
- 1 x long (60 mm) glare tube
- 1 x short (30 mm) glare tube
- 1 x glare tube spacer



Assembled Precision Sight with Long & Short Glare Tubes

\* Ring not included

**John Cooper Phone:** +61 2 9887 1947    **Mobile/Cell:** 0419 276 040

**Facsimile:** +61 2 98871668    **Email:** johncooper@coopertunnels.com

**Web:** www.coopertunnels.com

Continued from page 9



*Aussie team in New Zealand*

# CLUB INSURANCE

**Is Your Rifle Club and or Association Looking for a Competitive Price on your Club Insurance?**

If the answer is **YES**

Why not give **John Leask** a call from **QBN Insurance Services** who may have the answer.

John has developed a policy specifically for rifle clubs and associations using his 30 year experience as a target rifle shooter.

To Contact **John** please call  
**M: 0428 875 683**  
**john@qbninsurance.com.au**

**QBN INSURANCE SERVICES**  
*Insurance Broker for the NRAA*

Authorised Rep No: 310702 PSC Connect Pty Ltd AFS Licence 344648

*Specialist in Commercial Motor,  
 Heavy Motor/Plant, Rural, Small Business and Aviation*

however GB waited patiently to capitalise on a less fluctuating wind pattern and shot fast and accurately, to win eventually by 26 points over Australia. South Africa came third, 10 points behind Australia and the USA came fourth, 69 points behind South Africa.

The Australian Under 25's made history by winning the U25 Australia Match over the favourites Great Britain by two points and three centres. Australia last won this match in 2005. The team comprised: Captain - Dean Enslin (QLD), Coach - Chris Schwebel, (NSW) Manager - Andrew Sims (NSW) with shooters: Dean Enslin, Alex Davies (NSW), Nick Sims (NSW), David Smith (NSW) and Angus Martin (NSW). The South Africans finished third and Canada fourth.

The RSA international match was shot and used primarily as a practice for the open teams and resulted in GB in first place followed by RSA Australia and USA.

However, the RSA Under 25 International match was hotly contested for and was won by the Australian U25's followed again by GB RSA and Canada.

In the Open Protea Match, Australia took the lead by five points at 300 metres. After the 600 metres, the scores between GB and Australia were level and two in front of RSA, however the 900 metres was to be Australia's Achilles heel once again, allowing GB to win by 14 points. RSA came in second, two points ahead of Australia and the USA came fourth, 50 points behind Australia.

The Protea Under 25 Match went down to the wire once again with the Australian U25's making the Trifecta complete with a three-point win over GB. RSA



*The Aussie team having a braai - (BBQ)*



*Protea Match team*

and Canada were in third and fourth places respectively. Dean and Darren made history by being the first father and son to captain their respective teams at the same time in Target Rifle Shooting Australia. The two captains will pair up again for the World Long Range Championships to be held in New Zealand in January 2018. The first trial will be held later this year.

In the sport of Target Rifle Shooting, The Australia Match and the World Championships are the only times where a Team Member can officially wear the Prestigious Australian Coat of Arms.

For more information and results visit

[www.nraa.com.au](http://www.nraa.com.au)



*Andrew and son Angus Martin*



*Donna Negus accepts the Scottish Sword - the first woman to win it*

# HEXTA

## Match-Grade Targets

*Official targets for the 2017 NRAA Queens Prize*



**Congratulations to all the winners at the 2017 NRAA Queens Prize!**

*"I've always been skeptical about electronic targets, but the HEXTA targets were absolutely flawless."*

Geoff Grenfell, Queens Prize winner, Target Rifle

**The full deal for full bore.**

**Proudly Australian.**



Bruce Daniel  
0424 775 635



**HEX Systems**  
hexsystems.com.au

# SARA Championships 2017

By Janelle Traeger

The South Australian Rifle Association Hunt and Queens series were competed for on the Lower Light Rifle Range following the two days of the NRAA State F Class Teams event.

F Class shooters converged on Lower Light from all over Australia to contest these hard fought teams matches on a range that has become somewhat known as “the house of pain”.

I'm sure there will be other reports regarding the victorious South Australian F Standard and FTR teams plus other wins but please accept my congratulations on your well-deserved wins!

The first day of the Hunt series rolled around and it was evident that the weather for most of the SARA Championships event was going to spoil us. It was nothing like the “old notorious October weather” of previous past years, but was really cold.

After the two days of the Hunt it was evident that the winners in all disciplines would need to be concentrating for the long haul and only time would reveal the final winners.

In target rifle, locals Frank Pinyon (Cyclists/Torrens



The Winner, Paul Savage is chaired in...

Valley) and Brad Semmler (Light River) shot off for the Hunt Trophy with Semmler the eventual A Grade winner. Ann Chinnery from Queensland did enough in B Grade to take first place and C Grade was won by Cynthia Hollis (Darwin).

The F Class disciplines were won by Darren Bradley (Griffith District), Steve Wuttke (Murray Bridge) Rod Davies Cessnock) and Mark Fairbairn (Cannon Hill RSL) respectively.

## The Hunt Results

A Grade				
1	Brad Semmler	Light River	SA	298.29
2	Frank O. Pinyon	Cyclists & Torrens Valley	SA	298.29
3	Rick Ashton	Port Jackson Rifle Club Inc.	NSW	294.28
4	Rhyder Atkinson	Walleroo	SA	293.23
5	Bluey (Ian) Noll	Whyalla	SA	293.23
6	Tim Letts	Darwin	NT	292.30
B Grade				
1	Ann Chinnery	Marian Rifle Club	QLD	293.28
2	Malcolm Flavel	Whyalla	SA	288.24
3	Andrew Heard	Murray Bridge	SA	287.19
4	Harro (Gordon) Harrison	Murray Bridge	SA	286.18
5	Bill Ballantyne	Hornsby RSL	NSW	284.16
6	Carol Hulett	Geelong	VIC	281.27
C Grade				
1	Cynthia Hollis	Darwin	NT	277.16
2	Malcolm Challen	Phoenix Target	SA	277.14
F Standard A Grade				
1	Darren Bradley	Griffith District	NSW	349.25
2	Rob Halloran	Junee Ex-Services Memorial	NSW	345.17



Scores on the Board





Continued from page 12



A Grade - Hunt

3	Garry Warrender	Wangaratta	VIC	343.21
4	Edmund Kanik	Kapunda	SA	343.19
5	Nigel Hunt	Northampton	WA	341.16
6	Andrew McKillop	Bundaberg/Burnett	QLD	341.15

### F Standard B Grade

1	Steve Wuttke	Murray Bridge	SA	335.15
2	Jacinta Bradley	Griffith District	NSW	334.21
3	Chris Williams	Phoenix Target	SA	329.13
4	Anthony Daniel	Bungendore Rifle Club	ACT	328.12

### F Open

1	Rod Davies	Cessnock Rifle Club	NSW	357.27
2	Geoffrey Krake	Mildura - Red Cliffs	VIC	355.32
3	Colin Sutton	Goondiwindi	QLD	355.31
4	Stuart Braund	Cyclists Torrens	SA	354.24
5	Lowell Tillack	Goondiwindi	QLD	349.28
6	Michael Waites	Warragul/Drouin	VIC	347.22
7	Tim Nugent	Cessnock Rifle Club	NSW	345.24

### FTR

1	Mark Fairbairn	Cannon Hill RSL	QLD	352.22
---	----------------	-----------------	-----	--------



FS A - Hunt



C Grade - Hunt

2	Liam Hall	South Bendigo	VIC	347.24
3	Geoff Willis	Bathurst Rifle Club.	NSW	345.26
4	Tim Lawrence	Mackay Rifle Club	QLD	345.19
5	Nikki Slee	Cannon Hill RSL	QLD	343.24
6	Jason Mayers	Brisbane	QLD	341.21
7	Rodney Davis	South Bendigo	VIC	340.23
8	Dennis Formiatti	Canberra Rifle Club	ACT	340.16
9	Doug Chalmers	Robinvale	VIC	340.15

Then it was time for the real stuff - the SARA Queens prize!

The weather was kind; the mood was good; and thankfully most of the F Class shooters who travelled from afar stayed on to help boost the entry numbers.

Right from the start it was evident that the shooters from the Hunt series were still switched on. Once again Brad Semmler was shooting very well and in F Open our own Stuart Braund (Cyclists/Torrens Valley) was just "pipped at the post" by David Pearsall (North Sydney).



B Grade - Hunt





FTR - Hunt

In target rifle, Phil Bradshaw (Cyclists/Torrens Valley) was once again straight out of the blocks to finish the first day on top with Andrew Heard (Murray Bridge) and Dave "Butch" Lindner (Kapunda) in front in B and C Grade respectively.

Day two came around and after everyone thawed out from the cold, the story was starting to change.

Andrew McKillop (Bundaberg/ Burnett) took out the second day for F Standard A, Steve Wuttke was three points clear in F Standard B, Jeff Roberts (Phoenix Target) had the narrowest of leads in F Open and Nikki Slee (Cannon Hill RSL) was in charge in FTR.

In target rifle Paul Savage (Port Pirie) edged out Peter Maher (Lilydale) by a few centres to take out the second day aggregate in A Grade. B Grade went to Carol Hulett (Geelong) and "Butch" Lindner took out C Grade.

The final day came around and the fickle Lower Light wind was starting to raise its ugly head. Brad Semmler



FO - Hunt



FS B - Hunt

set the tone with a beautiful 50.9 at the first 800 metres. Frank Chester (Mareeba) and Malcolm Challen (Phoenix Target) were top in B and C Grade respectively.

Stuart Braund was showing a clean pair of heels in F Open, John Eland (Fitzroy/ Caulfield) in F Standard A and Michael Hoey (Central Australia) in F Standard B. Stephen Sharp (Bungendore) led the way in FTR.

A short break occurred as a last shot was fired by Don Cook, who was recently made a Life Member of SARA, in honour of his good friend and veteran shooter, Adrian Hobbs, who passed away after a short illness.

The last money range, 800 metres, was upon us and although the numbers were well down the interest was still high. Paul Savage in target rifle A Grade did enough to edge out Frank Pinyon by three centres to take out his maiden Queens event.

Ann Chinnery won convincingly in B Grade as did "Butch" Lindner in C Grade.

F Class Queens winners were Darren Bradley in F Standard A with his daughter, Jacinta absolutely "thumping" the competition in F Standard B.





**LRP Solutions**

For all your Long Range Precision Gunsmithing needs.

• Custom Built Rifles • Quality Workmanship

---

☺Borden Actions ☺Maddco Barrels ☺Bartlein Barrels ☺March Scopes

Contact: Matt Paroz  
Ph: 0402230877  
Email: matt@lrpsolutions.com.au  
Web: www.lrpsolutions.com.au

Australian Distributor for Barnard Actions and Spare Parts

For a list of Agents please refer to our website



Continued from page 15

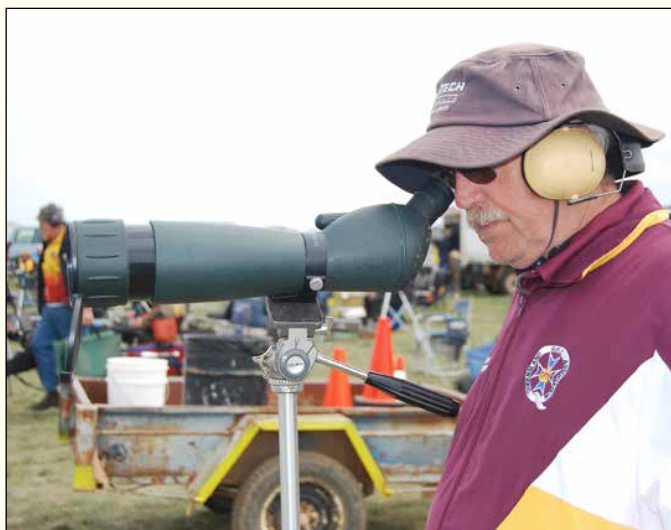

*Scoping out the competition*

The F Open Queens went to Stuart Braund winning convincingly from Michael Waites (Warragul/ Drouin) and Adam Pohl (Kapunda).

Chris Allman (Ravenshoe/Mt Garnet) was the overall winner in FTR.

In an interesting side note, all Grades except A Grade and F Standard A were won convincingly. Great shooting by all!

Grand Aggregate winners were: Frank Pinyon, Ann Chinnery, David Lindner, Darren Bradley, Jacinta Bradley, Stuart Braund and Mark Fairbairn.

Once again thanks go to all who attended, especially the F Class shooters who stayed to make this a great event.

**Queens Aggregate**

**A Grade**

1	Paul Savage	Port Pirie	SA	445.51
2	Frank O. Pinyon	Cyclists & Torrens Valley	SA	445.48
3	Peter Watkins	Subiaco	WA	440.51
4	Bluey (Ian) Noll	Whyalla	SA	439.36
5	Philip Bradshaw	Cyclists & Torrens Valley	SA	438.51
6	Rick Ashton	Port Jackson Rifle Club	NSW	437.46

**B Grade**

1	Ann Chinnery	Marian Rifle Club	QLD	438.40
2	Peter Hulett	Geelong	VIC	433.36
3	Bill Ballantyne	Hornsby RSL	NSW	432.27
4	Carol Hulett	Geelong	VIC	431.34
5	Andrew Heard	Murray Bridge	SA	429.35

**C Grade**

1	David Lindner	Kapunda	SA	418.17
2	John Cadd	Murray Bridge	SA	407.16
3	Don Flynn	Woomera	SA	396.23

**F Standard A Grade**

1	Darren Bradley	Griffith District	NSW	520.35
2	Andrew McKillop	Bundaberg/Burnett	QLD	520.29
3	Philip Brook	Brisbane	QLD	519.33
4	Edmund Kanik	Kapunda	SA	518.33

5	Mahlon Reid	Boddington 214	WA	514.33
6	Jason Nessling	Phoenix Target	SA	513.17
7	Malcolm Hill	Port Pirie	SA	508.26

**F Standard B Grade**

1	Jacinta Bradley	Griffith District	NSW	512.30
2	Chris Williams	Phoenix Target	SA	502.24
3	Steve Wuttke	Murray Bridge	SA	501.20
4	Ian Marks	Brisbane	QLD	500.24
5	Micheal Hoey	Central Australian	NT	497.17

**F Open**

1	Stuart Braund	Cyclists & Torrens Valley	SA	536.46
2	Michael Waites	Warragul/Drouin	VIC	530.47
3	Adam Pohl	Kapunda	SA	529.47
4	Lowell Tillack	Goondiwindi	QLD	528.38
5	Mark Tyler	Phoenix Target	SA	527.45
6	Jeff Roberts	Phoenix Target	SA	525.42
7	Rod Davies	Cessnock	NSW	525.41
8	Spencer Dunstall	Ungarie	NSW	525.41
9	John Brook	Gilgandra	NSW	525.39
10	Geoffrey Krake	Mildura - Red Cliffs	VIC	525.39

**FTR**

1	Chris Allman	Ravenshoe/Mt Garnet	QLD	522.38
2	Mark Fairbairn	Cannon Hill RSL	QLD	519.37
3	Liam Hall	South Bendigo	VIC	516.32
4	Mike Samuels	Beaudesert		515.25
5	Stephen Sharp	Bungendore Rifle Club	ACT	514.34
6	Anthony Pedersen	Canberra Rifle Club	ACT	514.34
7	Jason Li	Shepparton/Nathalia	VIC	514.28
8	Michael Punturiero	Loxton	SA	513.23
9	Tim Lawrence	Mackay Rifle Club	QLD	512.25
10	Nikki Slee	Cannon Hill RSL	QLD	511.30
11	Jason Mayers	Brisbane	QLD	511.24
12	Clifford Austen	Nowra Rifle Club	NSW	509.27

**Grand Aggregate**

**A Grade**

1	Frank O. Pinyon	Cyclists & Torrens Valley	SA	743.77
2	Paul Savage	Port Pirie	SA	736.79
3	Brad Semmler	Light River	SA	734.71
4	Bluey (Ian) Noll	Whyalla	SA	732.59
5	Rick Ashton	Port Jackson Rifle Club	NSW	731.74



*James Freebairn*



*Gordon Harrison*

<b>B Grade</b>				
1	Ann Chinnery	Marian Rifle Club	QLD	731.68
2	Andrew Heard	Murray Bridge	SA	716.54
3	Bill Ballantyne	Hornsby RSL	NSW	716.43
4	Carol Hulett	Geelong	VIC	712.61
5	Harro (Gordon) Harrison	Murray Bridge	SA	712.46

<b>C Grade</b>				
1	David Lindner	Kapunda	SA	692.27
2	Malcolm Challen	Phoenix Target	SA	673.32

<b>F Standard A Grade</b>				
1	Darren Bradley	Griffith District	NSW	869.60
2	Edmund Kanik	Kapunda	SA	861.52
3	Andrew McKillop	Bundaberg/Burnett	QLD	861.44
4	Rob Halloran	Junee Ex-Services	NSW	847.46
5	Nigel Hunt	Northampton	WA	844.40
6	Norman Cross	Gemfields	QLD	842.47
7	Mahlon Reid	Boddington	WA	841.53



*It's hard work...*

<b>F Standard B Grade</b>				
1	Jacinta Bradley	Griffith District	NSW	846.51
2	Steve Wuttke	Murray Bridge	SA	836.35
3	Chris Williams	Phoenix Target	SA	831.37

<b>F Open</b>				
1	Stuart Braund	Cyclists Torrens Valley	SA	890.70
2	Rod Davies	Cessnock	NSW	882.68
3	Geoffrey Krake	Mildura - Red Cliffs	VIC	880.71
4	Colin Sutton	Goondiwindi	QLD	880.66



*Janelle in the icecream van*



*Brad Semmler, winner of the Hunt*

<b>FTR</b>				
1	Mark Fairbairn	Cannon Hill RSL	QLD	871.59
2	Liam Hall	South Bendigo	VIC	863.56
3	Tim Lawrence	Mackay Rifle Club	QLD	857.44
4	Nikki Slee	Cannon Hill RSL	QLD	854.54
5	Jason Mayers	Brisbane	QLD	852.45
6	Stephen Sharp	Bungendore Rifle Club	ACT	848.51
7	Rodney Davis	South Bendigo	VIC	846.52
8	Doug Chalmers	Robinvale	VIC	846.40

# NRAA F Class National Teams South Australia

By Bob Pedersen

A total of 18 F Class Teams competed at Lower Light in the NRAA National Teams Match.

These comprised seven FTR teams, six F Open teams and five F Standard teams. This was the sixth match since the competition started in 2009 which was held at Bendigo Victoria, where at that match seven F Standard teams and two F Open teams entered.

This year the format of the match was changed and match one was 20 shots at 900 metres with match two 15 shots at 700, 800 and 900 metres.

The conditions were typical of Lower Light and this was very challenging at times for the wind coaches.

A good percentage of the Australian F Open and FTR teams were present, as they had recently had a full training session at the Kapunda Range, about an hour away from Lower Light.

It was interesting to see the growth in FTR which had the greatest number of teams, and on the whole, it all reflects on the huge growth in all of the F Class shooting disciplines.

The conditions at Lower Light are always challenging, and the South Australian organisers are to be congratulated for the way they presented the range and all the facilities. Many people took advantage of the new accommodation units available. Ample caravan space was provided and most also used the excellent dining facilities also available.

Lower Light put on its usual tricky wind conditions for the two days and kept all the coaches on their toes.



Michael Waites Victorian F Open Captain

Most days saw the wind starting at 9.00 o'clock and gradually working its way around through 6.00 o'clock until eventually settling around 2.00 o'clock. Certainly, a variety of conditions were on offer!

On the first day, after a practice session at all ranges in the morning, the Series opened at 900 metres with a 20 shot match. In FTR the winning team of NSW dropped 31 points and a testament to skills is that there was only a seven point spread amongst the first five teams! For F Open, Victoria only dropped 11 points; an



South Australian F Standard Team



Victorian F Open Team

equally meritorious performance. F Standard saw South Australia squeaking in by one point from two others.

The second day saw the Big Match, over three ranges, with South Australia FTR ahead by six points from NSW, who in turn had a clear victory in F Open by 21 points; the biggest margin for the whole match. F Standard had South Australia again taking the gong as well.

The day was followed by a presentation dinner held at the SA Harness Racing Club rooms. It was an outstanding event emceed by Brad Semmler, ably assisted by Reg Cunningham, Paul Gale, Rod Mahon



Queensland F Standard Team

(FTR Captain) and David McNamara (F Open Captain) as co-presenters.

Many congratulations go out to the South Australian Rifle Association for running such a successful meeting and also to Cath Berry, Colleen Morgan and all the other helpers. It was a great meeting!

**FTR**

	900m	7-8-900m	Grand Agg	Long Range Agg
ACT	554.27	1209.53	1763.80	921.37
New South Wales	569.30	1256.51	1825.81	959.39
South Australia	566.33	1262.59	1828.92	962.41
Western Australia	562.25	1215.47	1777.72	926.30
Victoria	563.19	1251.52	1814.72	951.29
Queensland	567.25	1251.61	1818.86	953.35
Nth Queensland	550.23	1226.49	1776.72	920.26

**F OPEN**

	900m	7-8-900m	Grand Agg	Long Range Agg
New South Wales	586.29	1317.103	1903.132	1015.52
Queensland	567.30	1273.80	1840.110	962.44
South Australia	586.37	1276.80	1862.119	976.44
Victoria	589.41	1294.86	1883.127	1004.54
Nth Queensland	578.34	1296.98	1874.132	998.53
Western Australia	582.36	1261.73	1843.109	979.49



## F Class Teams

Continued from page 19



New South Wales F Open Team

### F STANDARD

	900m	7- 8- 900m	Grand Agg	Long Range Agg
New South Wales	573.31	1243.62	1816.93	949.34
Queensland	573.33	1251.75	1824.108	956.39
South Australia	574.22	1261.76	1835.98	962.28
Victoria	554.19	1237.43	1791.62	936.23
Western Australia	567.31	1231.56	1808.87	946.38

Discipline	Match	Shooter	Coach	Score
F Standard	NSW Trophy	Jason Nessling	Malcolm Hill	377.23
F Open	NRAA Trophy	Lewis Reynolds	Greg Warran	386.33
FTR	NRAA Trophy	Mark Fairbairn	Mike Willment	379.28



Victorian Open 900 metre match

## Australian Target Rifle



Young South Australian boys



SA Board Member Jim Caspers and SA Chairman Reg Cunningham



New South Wales F Open - Jacinta Bradley

# The 142nd Victorian Championships

By Ken Reither Photos by Ken Reither, Peter Farley and Robyn Jackman

## The Planning

With no State team lead up shoot and the National Target Rifle Team in South Africa, we expected the entries to be down a bit this year, and sadly we were right. But aside from needing to arrange a few less markers, the necessary organisation had all the same ingredients. Inside the office, Robyn Jackman and Brett Thurtell were organising sponsorship, trophies, advertising, web site, range officials, markers, entry forms and the program booklet among other things. Along with Geoff Wells they also arranged the additional shop inventory to cope with our biggest sales week of the year. Outside it was Robin Hall, Morrie Jackman, Len Hayes and Michael Purden who took care of the watering, slashing, road grading, target repairs, mound marking, camping layout and ramp repairs - and so it goes on.

The Queens Team agreed that Robyn and Robin were the real heart of our preparation team; having worked the whole year to make this event the success that it was. A big thanks goes to our very own Dynamic Duo.

And finally, there's the catering. Thanks once again to Lee Wings for making all the necessary arrangements. It's a complex task but to the casual observer, Lee makes it look easy. Thanks also to Lachie Black for running the bar.



Dynamic Duo

## The Competition Management

The only advantage of lower entry numbers is that it makes an event easier to run with the bonus of an earlier finish each day. Chief Range Office Peter Hulett made the most of it with his team of Morrie Jackman, Caroline Nitschke, Carol Hulett and Len Hayes at the competitor end; and Chief Butts Officer Derek Boughton along with Ron and Ross Aldridge looking after the marking.



Michelle Fletcher, Brett Thurtell and Peter Farley

John Eland and Len Hayes arranged ammunition and rifle checking and Bruce Ellwood was helping out with arrangements for the daily prize lists. The usual statistics team of VRA Chairman Garry Kay and Councillors Frank Conner and Alan Wright were entering the results as soon as the cards were delivered and the scoreboard was kept up to date by a few volunteers including Michelle Fletcher, Brett Thurtell and the VRA's newest councillor, Peter Farley.



## VORTEX

GOLDEN EAGLE RIFLESCOPE  
15-60 X 52mm ECR-1 MOA Reticule



Competitive shooters require a very specific set of features to stay ahead of the competition.

The new Golden Eagle is a perfect solution. The 15-60x magnification, fine reticule, and positive and repeatable tracking are perfect for fine tuning that record shot. Plus, its relatively light 29.5 oz weight allows shooters to adhere to strict competition weight limits.

As with all Vortex products it also comes with Lifetime Warranty

Whether you're interested in F Class, Rimfire, or Bench Rest competitions, this is the scope for you

Call for availability and competitive pricing



**Graham Crowe**  
Wagga Wagga, NSW, 2650  
Mob 0428 620 538

Continued from page 21

The entry statistics were:

**Syme Entry Details**

Grade	A	B	C	FA	FB	FO	FTR	Total
Entries	39	12	2	16	13	8	6	96

**Queens Entry Details**

Grade	A	B	C	FA	FB	FO	FTR	Total
Entries	50	22	2	22	19	9	12	156

**The ANZAC Centenary Aggregate**

The Bendigo RSL once again sponsored the first day of the Syme - titled the ANZAC Centenary Aggregate - with up to three badges for each grade.

**ANZAC Centenary Badge Winners**

**TRA:** Graham Aitchison (Canberra) 150.2, James Corbett (Benalla) 149.22, Wendy Latham (Natives) 149.12,

**TRB:** Ross Jackson (Yarram) 147.14, Bill Pryde (Spalding) 145.13, Garry Walton (MCC) 144.15,

**TRC:** Blade Lacey (Maryborough) 136.1, Cynthia Hollis (Darwin) 136.5,

**FSA:** Trevor Rhodes (Maryborough) 178.11, Peter Johnstone (Marrickville) 176.15, John Simons (Broken Hill) 175.15,

**FSB:** Marty Kelly (ECDRA) 171.8, Allan Humbert (Roseville) 170.9, Wayne Latham (Natives) 170.6,

**FO:** Geoffrey Krake (Mildura-Red Cliffs) 179.13, Adam Davies (Maryborough) 177.12, Bob Pedersen (Wodonga) 176.15,

**FTR:** Rod Mahon (South Bendigo) 178.12, Doug Chalmers (Robinvale) 177.11, Alan Seaman (Manly) 174.7,

**The Syme Aggregate**

As you can see from the scores, conditions were far from easy. With some of the regular badge winners off in South Africa, it gave a chance for some newer names to creep into the list. Self-confessed "regular bridesmaid" Geoff Grosskreutz was very happy to collect the No.1 Target Rifle badge. It is interesting to note that F Standard A Grade and FTR were both won with a score of 340.16 and equally interesting that the winning FO score was all of nine points in front.

**Syme Aggregate Badge Winners**

**TRA:** Geoff Grosskreutz (Brisbane) 293.22, Graham Aitchison (Canberra) 292.31, John Snowden (Ashburton) 291.28, Rob Sandlant (Bendigo) 290.23, Don Thompson (Natives) 290.19, James Corbett (Benalla) 289.3, Wayne Boschetti (Marong) 289.24, Mijo Brdjanovic (Brisbane) 288.27, Nick Cock (Bathurst) 288.25, Michelle Fletcher (Wodonga) 288.22, David Brewster (Fitzroy/Caulfield)



ANZAC Centenary Winners (rear) Bob English (RSL VP), Graham Aitchison, Marty Kelly, Trevor Rhodes, Rod Mahon, Geoff Krake, Cliff Richards (RSL President) (front) Ross Jackson, Blade Lacey



## Australian Target Rifle

287.22, Brian Carter (Te Puke NZ) 287.21, Mal McKenzie (Wingham) 285.24, Rick Ashton (Port Jackson) 285.21, Wendy Latham (Natives) 285.2, Mark Horsnell (Bacchus Marsh) 284.23.

**TRB:** Garry Walton (MCC) 286.25, Barry White (Wingham) 280.2, Ann Chinnery (Marian) 278.17, Ross Jackson (Yarram) 277.21, Bill Pryde (Spalding) 277.17.

**TRC:** Cynthia Hollis (Darwin) 265.1.

**FSA:** Trevor Rhodes (Maryborough) 340.16, John Simons (Broken Hill) 333.19, Jenny Davies (Maryborough) 329.14, Peter Johnstone (Marrickville) 327.2, John Eland (Fitzroy/Caulfield) 323.14, Phillip Oliver (Sandford) 321.1.

**FSB:** Marty Kelly (ECDRA) 327.11, Kay Eland (Fitzroy/Caulfield) 319.1, Peter Drew (Brisbane) 318.19, Trevor Jury (Fitzroy/Caulfield) 316.1, Bob Harvey (Marrickville) 315.13.

**FO:** Geoffrey Krake (Mildura - Red Cliffs) 349.16, Adam Davies (Maryborough) 348.23, Bob Pedersen (Wodonga) 338.21.

**FTR:** Doug Chalmers (Robinvale) 340.16, Rod Mahon (South Bendigo) 336.14.

## The Queens

The winner of Target Rifle A Grade by a comfortable margin was James Corbett who now has four No.1 VRA Queens badges, to go with his many other No.1 badges from a variety of other competitions, including Bisley. F Open winner Geoffrey Krake also had a comfortable margin over his fellow grade competitors as well as the other F Class grades.

Piper Darryle Kenyon led the procession, as he has done for over twenty years, followed by CRO Peter Hulett, Queen's aggregate winners of each grade, the traditional line up of previous Queen's winners and the chaired A Grade winner, James Corbett. It is always



James Corbett being congratulated by CRO Peter Hulett, watched by Wayne Boschetti and Peter Maher

## Victorian Queens



Piper Darryle Kenyon

interesting to see how the chaired winner negotiates the doorway to the Frank Morgan Pavilion!

The Bendigo Deputy Mayor, Councillor Rod Fyffe was in attendance to present the Queens and Perc Pavey Grand Aggregate badges, as he has done for many years.



# Match Rifle & Long Range F Class 2017 Event Calendar

**June 10-11 2017**  
**Queensland MR & LR F Championships**  
*Raglan, Queensland*  
Practice- Friday June 9

**August 26-27 2017**  
**South Australian MR & LR F Championships**  
*Lower Light, Sth Australia*

**October 7-9 2017**  
**Ultra Long Range Challenge REVISITED!**  
*Coonabarabran, NSW*  
Competition over 1000, 1100, 1200 and 1500 yards  
Practice- Friday October 6 (pm)

**November 10-14 2017**  
**Australian Match Rifle & Long Range & F Class Championships**  
*Stawell, Victoria*  
Match Rifle - FTR - F (Open)  
Individual Comp - **Nov 10-13**  
**State Teams Match Rifle & F Class 13-14 Nov**  
*Discounted entry to the individual competition for all those shooting the National Championships for the first time and one lucky new Match Rifle shooter will get free entry.*

**November 9 2017**  
**Victorian MR & IR F Championships**  
*Stawell, Victoria*

More information on the above events at [www.matchrifle.org](http://www.matchrifle.org) or email [info@matchrifle.org](mailto:info@matchrifle.org)

*Continued from page 23*

**Queen's Aggregate Badge Winners**

**TRA:** James Corbett (Benalla) 396.47, Mal McKenzie (Wingham) 392.43, John Snowden (Ashburton) 391.42, Brian Carter (Te Puke NZ) 391.33, Mark Buchanan (Roseville) 390.41, David McIntosh (Canberra) 389.42, Mitchell Bailey (Holsworthy) 389.35, Mark Horsnell (Bacchus Marsh) 388.33, Geoff Grosskreutz (Brisbane) 388.29, Nick Cock (Bathurst) 387.4, Graham Aitchison (Canberra) 387.3, Ken Young (Southern Highlands) 386.32, Keirin McCamley (Shepparton/Nathalia) 385.31, Peter Maher (Lilydale) 385.31, Keith Toh (Werribee) 384.39, John Kiefer (Bendigo) 384.38, Peter O Dwyer (Katandra) 384.34, Stephen Williams (Bathurst) 384.29, Terry Hickey (Colac) 384.23, John Ashton (Port Jackson) 383.37.

**TRB:** Ross Jackson (Yarram) 385.35, Scott Brindley (Explorers) 382.24, Carol Hulett (Geelong) 381.22, Garry Walton (MCC) 380.23, Barry White (Wingham) 376.25, Bill Ballantyne (Hornsby RSL) 376.25, Tim Walter (Roseville) 374.24, Ann Chinnery (Marian) 371.3.

**TRC:** Cynthia Hollis (Darwin) 354.13.

**FSA:** John Simons (Broken Hill) 449.23, Trevor Rhodes (Maryborough) 449.12, Ian Troeth (Portland) 443.11, Grant Hornell (Hamilton) 442.2, Peter Johnstone (Marrickville) 441.16, Daniel Sandford (Hamilton) 440.3, Alan Taylor (Narromine-Dubbo) 439.25, Jenny Davies (Maryborough) 439.15.

**FSB:** Peter Drew (Brisbane) 439.2, Bob Harvey (Marrickville) 434.22, Wayne Latham (Natives) 425.14, Clive Simpson (Narromine-Dubbo) 425.12, Thomas Doxford (Nowra) 424.13, Trevor Jury (Fitzroy/Caulfield) 424.9.

**FO:** Geoffrey Krake (Mildura - Red Cliffs) 467.33, Adam Davies (Maryborough) 462.3, Paul Nyirati (Geelong) 458.27.

**FTR:** Stephen Sharp (Bungendore) 455.3, Rod Mahon (South Bendigo) 453.2, Geoff Willis (Bathurst) 453.17, Doug Chalmers (Robinvale) 452.28.

**Percy Pavey Grand Aggregate Badge Winners**

**TRA:** James Corbett (Benalla) 685.77, John Snowden (Ashburton) 682.7, Geoff Grosskreutz (Brisbane) 681.51, Graham Aitchison (Canberra) 679.61, Brian Carter (Te Puke NZ) 678.54, Mal McKenzie (Wingham)



*Liam Hall, Rod Mahon and Michael Hall*



*Jenny Davies and Tess Pearce*

677.67, Nick Cock (Bathurst) 675.65, Rob Sandlant (Bendigo) 672.6, Wayne Boschetti (Marong) 672.59, Mark Horsnell (Bacchus Marsh) 672.56, Don Thompson (Natives) 672.48, Mark Buchanan (Roseville) 671.62, Mijo Brdjanovic (Brisbane) 671.57, David McIntosh (Canberra) 670.63, David Brewster (Fitzroy/Caulfield) 670.55, Ken Young (Southern Highlands) 670.53.

**TRB:** Garry Walton (MCC) 666.48, Ross Jackson (Yarram) 662.56, Barry White (Wingham) 656.45, Bill Ballantyne (Hornsby RSL) 649.47, Ann Chinnery (Marian) 649.47.

**TRC:** Cynthia Hollis (Darwin) 619.23.

**FSA:** Trevor Rhodes (Maryborough) 789.28, John Simons (Broken Hill) 782.42, Peter Johnstone (Marrickville) 768.36, Jenny Davies (Maryborough) 768.29, John Eland (Fitzroy/Caulfield) 759.31, Alan Taylor (Narromine-Dubbo) 758.46.

**FSB:** Peter Drew (Brisbane) 757.39, Bob Harvey (Marrickville) 749.35, Marty Kelly (ECDRA) 742.27, Trevor Jury (Fitzroy/Caulfield) 740.19, Wayne Latham (Natives) 737.23.

**FO:** Geoffrey Krake (Mildura - Red Cliffs) 816.49, Adam Davies (Maryborough) 810.53, Roger Teal (Portland) 787.34.

**FTR:** Doug Chalmers (Robinvale) 792.44, Rod Mahon (South Bendigo) 789.34.

**Footnotes**

Despite daily reminders to shooters, sometimes they still forget to put their completed card in the box provided - which holds up the publication of results. Does this only happen in Victoria? Fortunately, this year it didn't happen on the last range of the last day, so presentations started on time. We are also short on photos of aggregate winners because many camera-shy shooters disappear as soon as presentations are over.

We are very grateful to all the sponsors of this year's event, most of whom have been supporting us for many years. We couldn't run the event in this format without you all. For those who make special requests to sponsor a particular match, we do our best but it is not always possible and we allocate an event as close in spirit to the request as we can.

We look forward to seeing all the regulars (plus some newcomers) back at the Wellsford range on April 18, 2018, straight after the Commonwealth Games, when we'll start it all over again!



# NEW SOUTH WALES RIFLE ASSOCIATION INC. 141<sup>st</sup> Annual Open Championships

## ANZAC RIFLE RANGE, MALABAR - September 13 - September 17, 2017

### Wednesday September 13

McIntosh 1st Stage: 300,300, 600 & 600m

### Thursday September 14

McIntosh 2nd Stage: 700, 700, 800 & 800m

### Friday September 15

Queen's 1st Stage: 300, 600, 600m

Sargard Teams Match: 600m\* (15 Shots)

### Saturday September 16

Queen's 2nd Stage: 500, 500, 700 & 700m

### Sunday September 17

Queen's 3rd Stage: 800 & 800m\* (15 Shots)

➤ Electronic Targets will be used for all Target Rifle Events

➤ Manual Targets will be used for all F Class Events

Office use ENTRY No.

## INDIVIDUAL ENTRY FORM - ALL DISCIPLINES

### 1. Personal Details

*Please print carefully*

Surname: .....

Given names: .....

Date of Birth: .....

Club/Unit: .....

Postal Address: .....

Suburb: .....

State: ..... Postcode: .....

Telephone: .....

Fax/email: .....

State Association Membership No: .....

Shooters Licence/Permit No: .....

Licence must be shown at entry Collection

Expiry Date: \_\_\_\_ / \_\_\_\_ / \_\_\_\_

Left Handed: No  Yes  NRAA SID: .....

### 2. Special Entry Categories

*Please tick boxes as appropriate:*

Junior Shooter (TR) (Under 21 years as at first day of match)

Under 25 Shooter (TR) (Under 25 years as at first day of match)

School Shooter (TR) (Fulltime secondary Student)

Veteran (TR) (Over the age of 60 years as at first day of match)

F Class Junior (Under 21 years as at first day of match)

Lady (TR)

Cadet (TR)

(Serving Cadets in Army CC, Navy C, Air TC)

Tyro (TR)

AARA Trophy (TR)

(Only open to AARA members. Queen Agg. TR)

Police Trophies (TR)

**Paul Burmistriv Memorial Trophy**

**Sen. Sgt. John Murphy Memorial Trophy**

(Open to serving members of any Overseas, Interstate, Commonwealth or NSW Police Force as well as retired members of the NSW Police Force and any member of the NSW Police Rifle Club)



*The Executive reserves the right to alter the Programme, Badge/Prize Money according to entries.*  
Member, Sport NSW Inc

# INDIVIDUAL ENTRY FORM - ALL DISCIPLINES - Page 2

Surname: .....

### 3. Target Rifle Matches

Tick grade: A Grade  B Grade  C Grade   
 FA  FB  FO  FTR

#### J.G. McIntosh September 13-14

All TR, All F Class FTR .....\$120.00

#### Queens and Belt Series September 15-17

All TR, All F Class FTR .....\$150.00

### 4. Ammunition

Will be available for purchase from the NSWRA Store @ prices current @ the time of collection and payment.

Please indicate number of rounds and type of projectile required.

.308 .....   
 .223 (Sierra) .....

### 5. Accommodation

Powered Caravan/Tent Site (per night)....\$25.00  
 from ..... to ..... = Total amount \$

Unpowered Caravan/Tent Site (per night) \$10.00  
 (Includes vans connected to club units)  
 from ..... to ..... = Total amount \$

Hut Accommodation (per night) ..... \$15.00  
 from ..... to ..... = Total amount \$

Bed included (no bedding)

Bedding hire (per night) .....\$5.00  
 (incl. 2 sheets, blanket, 1 pillow) \$

### 6. Range User Fee

Range User Fee - **Must be included** + \$15.00

TOTAL FEES PAYABLE \$

**There is a \$15.00 (Inc GST) charge for the ANZAC Range user fee. The one charge covers all shooting events entered for the week.**

### 7. Late Entry Fee of \$10.00

(If Entry received after 8th September) \$

### 8. I enclose payment by:

CASH (at office only, do not post) .....

CHEQUE (payable to NSW Rifle Association Inc) .....

MONEY ORDER .....

### CREDIT CARD

VISA  MASTERCARD

Card No:

Expiry Date:  /

Name on Card: .....

Signature: .....

## ALL PRICES INCLUDE GST

**RETURN THIS FORM WITH YOUR REMITTANCE TO:**

**Championship Entry**

**NSWRA INC**

**PO BOX 386**

**MAROUBRA NSW 2036**

**or email: info@nswra.org.au**

**or Fax: (02) 9661 6042**

### OFFICE USE ONLY

Date Rec'd: \_\_\_/\_\_\_/17 [ ] Checked [ ] D/B Inv. No. \_\_\_\_\_ Chq/Card No. \_\_\_\_\_ Entry No. \_\_\_\_\_

# Connected to the Grid



Article by Tim Boase  
Photos courtesy of LBS

“There’s a way to do it better – find it.” – Thomas A Edison  
Somewhat unexpectedly at the end of 2016, Ipswich and District Rifle Club embarked on a quest to power their club house. About seven years earlier the Club had a tilt at securing grant funding to connect to the grid.

There were a few issues which proved to hinder the progress - the main being expense. Our club house was a considerable distance from grid infrastructure and the rising electricity prices would be hard to manage for our little club anyway. The only option would be off the grid. The club was fortunate to acquire by generous donation seven near new solar panels; the foundation of the project. Suddenly it seemed power was within reach. Photovoltaic panels were one thing but to survive off grid we would need power storage and a charging system. Typically, these were very accessible and a 24v system using deep cycle lead acid batteries seemed the logical solution. Little did I expect a conversation over Christmas lunch would open the door to a better way. It was December 25 and the constant drizzle made the

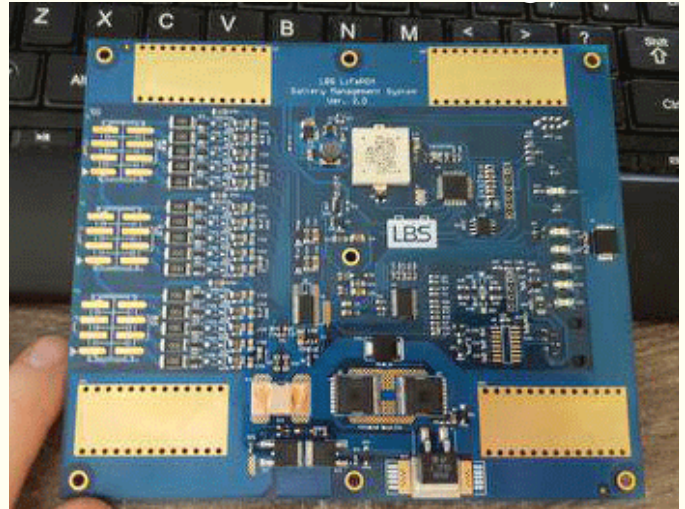

middle of summer unexpectedly comfortable; otherwise it was a fairly standard family Christmas. The day was full of good times together and the opportunity to catch up with those you hadn’t seen for a while; ‘How’s it going?’, ‘Whatch’a been up to?’ It was my Uncle Chris’ answer to the latter which had my ears prick. ‘Actually, I’m into this new business; Lithium Battery Systems.’ The more he told me the more the gears turned - this sounds like what we need for the clubhouse I thought. He told me all about the Brisbane business and their superior product. He explained that he was working with talented electrical engineers who’d been working in the industry for years. Their product was 12v lithium iron phosphate batteries designed to replace deep cycle lead acid batteries for off grid power in motor homes, caravans, boats, etc. They ordered top quality battery cells from China (like everything...) and built them in series supported by their locally designed and manufactured battery management system (bms). The product was then encased in robust aluminium housing.

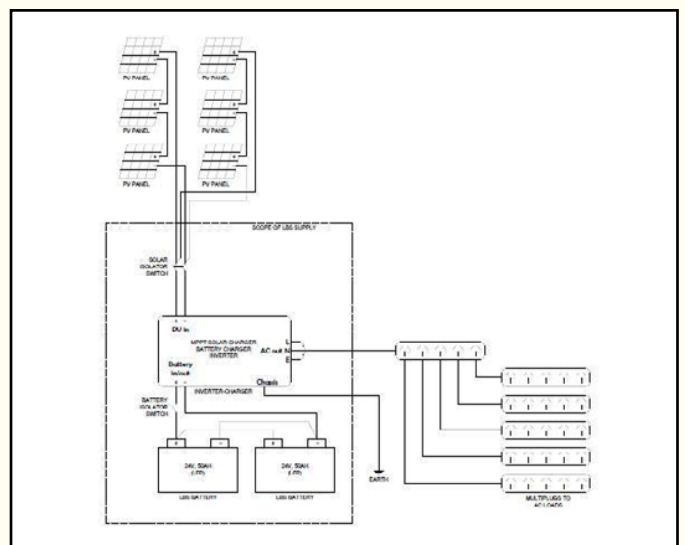

# Does Target Rifle Shooting Have a Death Wish?

By Peter Farley

Target shooting, like many traditional sports is slowly declining either in absolute numbers or in relative terms as a percentage of the population. We all struggle with this question, but in our case, is this decline preventable or reversible? I believe the rifle shooting movement has made many initiatives such as introducing, Eagle eyes, F Class, F Open, electronic targets etc. that have postponed the decline and enlivened the sport. However, I think that some of the changes, have had unintended consequences that have made it more difficult for the sport to survive.

In fact, I think target rifle in particular is facing a "Kodak Moment" and if we don't adapt to change we will die.

I have been thinking about what we can do to make shooting easier for newcomers and casual shooters like me, for some time. It seems to me that shooting has the great advantage that one can shoot as long as you can stand up and remember your name. On the other hand, for a new shooter, getting established is much more difficult than it used to be. Some of this is tighter gun laws but most of it is our own doing.

Some random information I have come across over the last few years:

- I read a story in a United States newspaper that paint ball shooting had declined 30% in two or three years. It seemed that the cause had been that the enthusiast players had introduced high performance paint ball guns (with much higher prices) so that newcomers and less dedicated players could not compete, thus competitions declined because only the most committed people with plenty of cash could compete.
- I went to a come and try day at a shotgun range. I discovered
  - a. that almost all shooters use factory ammunition and because there is a large market, the price differential between reloads and new was relatively small. This meant that even though there was an apparent price premium for everyone, competition was enhanced because everyone was on an equal playing field.

- b. Shotguns are relatively cheap and readily available so that if a new shooter wants to get his own gear he can order a new gun and be fully set up within a month
- c. Shotgunners spent almost all their time either shooting or socialising with other shooters. They usually don't spend time and money loading ammunition, testing loads or playing with all sorts of arcane gun smithing variables.
- d. The cost of a complete trap shooting kit that is good enough for most shooters is around \$3,000-\$3,500.
  - I was speaking to someone from one rifle club who told me that when newcomers came to the club, the club gave them a sheet detailing all the costs. The people read it and never returned. Clearly this was an unsuccessful recruiting strategy.
  - I went to a prize meeting recently where there was only one entrant in A Grade target rifle.
  - Some years ago, I spoke to a new shooter who was relatively young and he explained that he skipped target rifle and went straight to F Class as it was cheaper, (no jacket, no spotting scope and the telescopic sight was about the same cost as a full set of aperture sights).
  - I went to a rifle range in Switzerland where I was made very welcome and lent gear by three different people. Like everyone else there, I bought factory ammunition and shot under the same conditions.
  - There is a move on at the IOC to remove the 50 metre prone match from the program because it is viewed as technology dominant rather than skill dominant. If that is the case in smallbore it is far more so in fullbore.

Thinking about these issues, I feel we have made it too difficult to get into the sport and then it is a daunting task for a new shooter to work out whether his lack of performance is due to ammunition, rifle or technique. Finally, for young shooters who generally work more hours and are more likely to be involved with children's



*Continued from page 27*

The benefit of lithium batteries was extraordinary. Like in your mobile phone lithium batteries are a feather in comparison to the lead acid alternative. Unlike lead acid batteries which can only be used down to 30% from full charge, lithium batteries have a depth of discharge of around 70%. Lithium batteries also supply a much higher flow of amps to keep high draw appliances like a kettle or microwave from overloading the system. Just like a cordless drill, with the right charging set up lithium batteries can be charged to capacity in a fraction of the time of alternatives. As though all of this wasn't good enough, Lithium batteries can last three times the charging cycles of the standard lead acid battery. What a product! The only possible downside would be the price. I left Christmas lunch with an LBS brochure and a head full of ideas. Lithium Batteries would be a terrific option for IDRC's clubhouse. I had to let the club know about this option. After one look at the

LBS website the guys were keen to find out more. Early enquiries were responded to promptly. All technical questions were answered and two tailored systems were proposed to cater for our specific needs. The quotes we received were extremely competitive (about 1/10 of the price to connect to the grid). After selecting our preferred option, we placed an order with LBS. Within a few weeks the product was delivered and installed in a timely manner. Their after sales service was second to none. Our state of the art LBS battery system has been operating effectively for a couple of months now. We had a few minor issues in the first couple of months or so, which is to be expected. Since then the LBS system has been tweaked for optimum efficiency and it has easily met all of our expectations. With no ongoing costs, this system has proven to be the better way and I'm glad we found it. To find out what Lithium Battery Systems can do for you check out their website. <http://www.lithiumbatterysystems.com.au/>

activities on Saturday than people of my generation, they don't have the time or money for reloading, ammunition testing etc.

Some Suggestions for Making the Sport More Approachable

1. Call for expressions of interest from firearms manufacturers to develop a standard rifle with a basic stock with adjustable cheek piece and simply adjustable butt plate which can achieve 200mm groups at 600 yards at a price goal of \$3,500 (including sights and hand stop). The NRAA or the larger state associations would guarantee to buy perhaps 20 units and keep at least five in stock so that a new shooter could have a rifle within two weeks of getting a permit to acquire.
2. Consider returning to the days of a limited number of actions or at least a maximum list price for a barrelled action.
3. Limit the range of grades and competitions. We probably need to choose between F Class and FTR or just return to the original F Class with a bipod fixed to the rifle and included in the weight. It may sound strange but I think F Open can be preserved as an experimental class so that every five years or so we can look at developments in that class and see what can be transferred to the standard classes.
4. Standardise ammunition in two phases:
  - a. Limit the number of projectile variations to two

or three so that any new projectile must displace another in the range with no more than a 12-month changeover in competition. A similar limit could be placed on brass, powder and primers.

- b. Return to standard ammunition for major competitions, just like Bisley and the Commonwealth Games. Tenders would be called from ammunition suppliers for one or two suppliers to supply all the ammunition for two years. Selection would be based on a combination of performance, price and guaranteed minimum stockholding.

While these changes might seem to increase costs, in other ways they can reduce costs by reducing the expenditure on load development and increasing the volumes and therefore lowering the costs for the key suppliers, including State Rifle Associations who are stuck with unmanageable stocks of components and sometimes almost unsaleable stock of suddenly unfashionable brands.

I have one more left field suggestion. Rather than any further reductions in target size, make A Grade competition shoot on F Class targets - then there will be no shoot-offs and 50.1 wouldn't beat 49.7 (56.x).

I hope that the evidence in the United Kingdom where participation is growing and Switzerland where shooting is more popular than golf, might persuade some to have another look at our sport.



**SUMO 30mm Fixed Height Front Sight**

- ◆ Robust fixed height mount
- ◆ Accepts 30mm irises by others
- ◆ Integral spirit level



**SUMO 30mm Height Adjustable Front Sight**

- ◆ 5 moa elevation adjustments
- ◆ Integral spirit level

Sumo 30mm Fixed height tunnel (no lens or rings)	\$330.00
Sumo 30 Height Adjustable tunnel (no lens or rings)	\$460.00
30mm individual rings (most sizes available 2.0 to 9.8mm)	\$8.50 each
30mm full ring set of 25 (3.0mm to 7.8mm) 1,2 or 3mm annulus	\$110.00
+0.3 or +0.5 lens—Ziess CR39 Multicoat lens	\$60.50

**Barnard Scope Rail**

- \* 20 moa incline
- \* 205mm long
- \* Picatinny slot spacing
- \* 4 high tensile mounting screws
- \* Anodised black aluminium

**Sumo Prescription Lens Holder**

- \* Our 2 piece lens holder screws into the 9.5mm thread in the front of your existing rear sight.
- \* Have your Optometrist grind a lens to suit.



**\$65.00 plus \$10 postage**



**FREE DELIVERY ON ORDERS OVER \$200!**



Contact Ryan Neilsen  
Buy online, post a cheque or visit me at Belmont

[www.sumosight.com](http://www.sumosight.com)

email: [ryan@sumosight.com](mailto:ryan@sumosight.com)  
PO Box 4330, Gumdale QLD 4154  
Ph: 0447-119-987

**Also available through NSWRA Store & Bartlein Barrels NZ**

# Stawell's Big Bore Prize Meeting

By George Holden

Shooters from across Victoria, Mount Gambier and Broken Hill converged on Stawell for the Mother's Day weekend to compete in the Stawell Rifle Club's 64th Open, two-day Big Bore Prize Meeting.

The weather forecast was spot on, with near perfect conditions - all the A Grade squad achieved possibles first up at 500 yards, with solid scores achieved in the other six divisions.

Peter Maher, 50.7 took the lead in A Grade, one centre ahead of both Keirin McCamley and Mark Horsnell. Peter Setford was successful in B Grade with 49.4, two centres ahead of both Tony McRae and Doug Ratcliff. In C Grade Blade Lacey - our only Junior competitor, led off with 49.3 - one centre ahead of Dale Vanderhorst and a point ahead of Brian McKenna in third. In F Standard A Grade, John Simons led with 60.7 over Bruce Sergeant next with 60.6 and Grant Hornell on 60.5. Noel Osborn was a lonely, only entrant in F Standard B Grade and achieved 58.3.

In F Open Robert Bant, who was celebrating his 70th birthday, led with 59.4 over Bill Boyack by two centres and Paul McCarthy in third place. FTR saw Robert Chiswell win with 58.4 and Leo Stigger one centre behind, followed by Paul Murphy another centre down.

This year we avoided 300 yards and to compensate, scheduled 15 shot matches for 600 and 700 yards.

In A Grade at 600 yards, Ray Tapps punched out a 75.10 ahead of Peter Maher and Mark Horsnell, both on 74.9. B Grade winner was Tony McRae on 73.7, followed by Doug Ratcliff on 73.6 and Shannon Dyer on 73.5. Dale Vanderhorst in C Grade on 72.6 led Blade Lacey on 72.5 with Brian McKenna third with 71.4.

F Standard A Grade saw Daniel Sandford ahead with 88.8, Jason O'Rourke on 88.6 and Joe Melbourne next with 87.5. In F Standard B Grade it was Noel Osborn with 84.2.

F Open resulted in the 500 yard place getters in reverse order - Paul



Paul Murphy receiving the Eales Memorial Trophy from John Kelly on behalf of Graeme Eales and his family

McCarthy 88.1, Bill Boyack 87.5 and Robert Bant 86.5.

So, it was back to 700 yards with still pretty mild conditions. Mark Horsnell led again in A Grade with 75.10, Keirin McCamley next with 74.7 and Richard Tapps 74.6.

In B Grade Peter Farley was out the front with 73.4 ahead of Doug Ratcliff 72.5 and Richard Lane 71.3. The C Grade winners were Blade Lacey again with 71.7, Dale Vanderhorst 71.3 and Brian McKenna 69.4.

In F Standard A Grade the top three all got 88/90: Joe Melbourne with seven centres, Daniel Sandford seven centres and John Simons four. Noel Osborn in F Standard B Grade scored 78.3. In F Open three shooters were sharing 88/90: Bill Boyack with seven centres, plus Wayne Skinner and Robert Bant with four each. In FTR Paul Murphy scored 83.5, Robert Chiswell 82.5 and Leo Stigger 81.3.

The First Day Aggregate list below shows the three top positions in each grade:

A Grade	
Mark Horsnell	199.25
Raymond Tapps	199.18
Peter Maher	198.20

## B Grade

Doug Ratcliff	194.13
Peter Farley	191.12
Tony McRae	190.12

## C Grade

Blade Lacey	192.15
Dale Vanderhorst	192.11
Brian McKenna	188.12

## F Standard A

Daniel Sandford	235.20
Joe Melbourne	234.18
John Simons	234.16

## F Standard B

Noel Osborn	220.8
-------------	-------

## F Open

Bill Boyack	234.14
Robert Bant	233.13
Paul McCarthy	233.10

## FTR

Paul Murphy	226.14
Leo Stigger	224.10
Robert Chiswell	221.13

Thanks are extended to our Office staff, Cath and Ted Holden with valuable help from Alan Wright (VRA Councillor and NRAA Prizeware Guru). The first day presentations were made with VRA Councillor Morrie Jackman presenting the gold medallions to range winners and Alan Wright the





The presentation table on day one

trophies of VRA vouchers to the Day's Aggregate winners. This was followed by a BBQ tea which was enjoyed by all.

On Sunday morning the weather was still fine with light breezes at 800 yards. Again, all the A Graders achieved possibles: Richard Tapps 50.8, Flavi Konieczny 50.7 and Mark Horsnell 50.6.

The B Grade winner was Shannon Dyer 50.7 with Peter Farley 50.6 and Peter Setford 49.6. In C Grade Dale Vanderhorst led with 48.6 from Blade Lacey 47.3 and Richard McRae 46.4.

The top five in F Standard A Grade achieved possible 60's with Graeme Kerr 60.7 on count back from Grant Hornell 60.7 and Trevor Rhodes 60.6. In F Standard B Grade Noel Osborn with 60.7 would have been right up there in FA.

Alan Taylor in F Open led with 60.6 over Robert Bant 60.5 and Bill Boyack 60.4. In FTR Robert Chiswell had 60.4 and Paul Murphy 57.6.

At 900 yards some errant wind and mirage changes caused the odd heartache and curse, but most came through reasonably well.

The first three in A Grade all recorded possibles: Ray Tapps with five, Dad Richard with four and Mark Horsnell with three centres.

In B Grade Peter Setford with 47.4 was ahead of Doug Ratcliff 47.3 and Peter Farley 46.2. In C Grade Blade Lacey 50.4 was in front of Brian McKenna 46.3 and Richard McRae 45.3. The best four in F Standard A Grade all had 58/60 - Daniel Sandford ahead of Grant Hornell on count back with four centres and Trevor Rhodes with three centres. Noel Osborn was equal to more than midway up the FA list with 57.4.

In F Open - Paul McCarthy scored 58.4, Bill Boyack 57.2 and Roger Teal 56.3. Robert Chiswell in FTR again was ahead of Paul Murphy 55.0 to 52.2.

Now it was back to 1,000 yards and up slope significantly and this time those little wind and mirage changes had some big effects. It didn't worry Mark Horsnell with 50.2 or Ray Tapps with 49.4. Keirin McCamley got 47.2 and the rest went downhill from there.

In B Grade Shannon Dyer's 46.1 headed Peter Farley and Doug Ratcliff both on 42.3. Blade Lacey in C Grade with 47.3 just beat Brian McKenna with 47.2 and Greg Gunn was third with 45.1.

In F Standard A Grade Alan Wright carded 55.1, Morrie Jackman 54.3 and Grant Hornell 53.2. In F Standard B Grade Noel Osborn was still competitive with FA scores with 55.1.

Roger Teal was the winner in F Open on 54.1 ahead of both Paul McCarthy and Robert Bant on 51.1. FTR saw Paul Murphy 56.0 ahead of Robert Chiswell on 54.2.

The presentations followed fairly promptly with the day's medallions to range winners presented by VRA Councillor Peter Farley, as well as trophies (vouchers) to the Second Day Aggregate winners.

**A Grade**

Mark Horsnell	150.11
Raymond Tapps	149.14
Richard Tapps	145.15

**B Grade**

Shannon Dyer	140.9
Peter Farley	138.11
Doug Ratcliff	138.9

**C Grade**

Blade Lacey	144.10
Dale Vanderhorst	135.7
Brian McKenna	134.6

**FA**

Alan Wright	172.6
Grant Hornell	171.13
Trevor Rhodes	171.9

**FB**

Noel Osborn	172.12
-------------	--------

**F Open**

Roger Teal	169.7
Paul McCarthy	168.8
Robert Bant	166.8

**FTR**

Robert Chiswell	169.8
Paul Murphy	165.8

Peter Farley also presented the Grand Aggregate trophies, badges and sashes, except for the Eales Memorial trophy donated by the Eales Family, which was presented on behalf of Graeme Eales by John Kelly.

**Grand Aggregate Winners were:**

**A Grade**

- 1<sup>st</sup> badge, sash and trophy Mark Horsnell, Bacchus Marsh 349.36
- 2<sup>nd</sup> badge Raymond Tapps, Lilydale 348.32
- 3<sup>rd</sup> badge Peter Maher, Lilydale 342.35



Continued from page 31



Most Central Bulls / Super Centres winners – Peter Farley B Grade, Alan Salter F Open, Noel Osborn F Class B Grade, Mark Horsnell A Grade, Paul Murphy FTR, In front – Blade Lacey C Grade, Dan Sandford F Class A Grade

**B Grade**

1<sup>st</sup> badge, sash and Hateley trophy  
Doug Ratcliff, Maryborough 332.22

2<sup>nd</sup> badge  
Peter Farley, MCC 329.23

**C Grade**

1<sup>st</sup> badge, sash and trophy  
Blade Lacey, Maryborough 336.25

**F Standard A Grade**

1<sup>st</sup> badge, sash and trophy  
Grant Hornell, Hamilton 403.25

2<sup>nd</sup> badge  
Daniel Sandford, Hamilton 402.30

3<sup>rd</sup> badge  
John Simons, Broken Hill 401.25

**Grade**

1<sup>st</sup> badge, sash and trophy  
Noel Osborn, Rosedale 392.20

**F Open**

1<sup>st</sup> badge, sash and Eales trophy  
Paul McCarthy, Stawell 401.18

2<sup>nd</sup> badge

Robert Bant, South Bendigo 399.21

**FTR**

1<sup>st</sup> badge, sash and trophy  
Paul Murphy, Lilydale 391.22

2<sup>nd</sup> badge

Robert Chiswell, Bacchus Marsh  
390.21

Other trophies presented were

**Veteran, Target Rifle**

Peter Maher 342.35

**Veteran, F Class**

Grant Hornell 403.25

**Super Veteran, Target Rifle**

Peter Setford 320.21

**Super Veteran, F Class**

Robert Bant 399.21

**Junior Trophy**

Blade Lacey

**Two year aggregate, Target Rifle**

Peter Maher

**Two year aggregate, F Class**

Dan Sandford

**Most Central Bulls / Super Centres**

**A Grade**

Mark Horsnell 36

**B Grade**

Peter Farley 23

**C Grade**

Blade Lacey 25

**FA**

Dan Sandford 30

**FB**

Noel Osborn 20

**F Open**

Alan Taylor 23

**FTR**

Paul Murphy 22

The Stawell Rifle Club greatly appreciates the support of our sponsors and the competitors who supported our Prize Meeting.

# Easter at Glenrowan

By Geoff Doig

Federal Treasurer Scott Morrison recently enunciated “All Australians must tighten their belts.” The shooters who attended the two-day Easter Shoot at Glenrowan went a step further, they tightened their groups, with some awesome scores recorded.

On Easter Saturday, the Ovens and Murray Rifle Association hosted its 102nd prize shoot, consisting of two 10 shot matches at 500 yards, and a 15 shot match at 600 yards.

Many clubs in the area either don't shoot during the summer months, or do very little shooting. Now that we are experiencing the most glorious of autumn weather, many shooters were figuratively “chomping at the



Gayle Sewell, winner of the two-day aggregate



Chairing the winner

bit”, eager to have some gunsmoke waft through their nasal cavities.

A total of 79 shooters lined up at 8.30am for the first 500 yard match. At 600 yards was a 15 shot range. Some excellent shooting saw the first two competitors in both Target Rifle A and B Grades come through the day without losing skin.

## Day One Winners

Target Rifle A Grade	
Mark Horsnell	175.23
Pedro Daldy	175.16
Geoff Grenfell	174.26
Target Rifle B Grade	
Gayle Sewell	175.19



Continued from page 33



Winners are grinners...

Greg Cavanagh	175.13
Emma Coen	171.14

**Target Rifle C Grade**

Paul Diffey	166.9
Richard McRae	165.14
Blade Lacey	165.7

**F Class A Grade**

Bruce Serjeant	206.19
Garry Warrender	206.13
Joe Melbourne	205.15

**F Class B Grade**

Jason O'Rourke	205.9
Alan Wright	204.10
Marty Kelly	202.12

**F Class Open**

Geoff Krake	209.19
Rob Bant	208.16
Phil Giddens	207.18

**F Class Target Rifle**

Jason Li	205.13
Rod Mahon	204.10

After a long day on the range, most shooters were feeling a tad peckish. Di Jonker, and her team had done a marvellous job with catering during the day. Once the

daily presentations were wound up, and a few refreshing drinks consumed, Chef Extraordinaire Sambo Sandford and the superlative kitchen team consisting of Joyce Asquith, Di Jonker, Heather Hass, and Pauline Brown, put on a most superb roast dinner followed by a cheesecake dessert. Some diners were fully sated after the first course, and forwent sweets.

There is more to rifle shooting than launching a projectile at 3000 fps onto a piece of paper between 300 and 1000 yards away.

Shooters may compete fiercely on the mound, but as soon as the range officer closes the range at the end of the day's shooting, everyone becomes good friends, as was easily seen at the above-mentioned dinner. One could sense a great atmosphere and feeling of camaraderie amongst the diners, and everyone thoroughly enjoyed themselves. Easter at Glenrowan must be close to target shooting utopia.

After a few short hours sleep, most of the campers were astir at dawn,

eager for another day of splendid shooting. The Wangaratta Rifle Clubs Annual "Metric" prize shoot got underway at 8:30am, although some competitors were pacing up and down, chomping at the bit. A total of 61 entries were received.

The words "shooting gallery" were brandished about a few times.

Shooting consisted of 300 metre, 500 metre and 600 metre ranges. At the start of the last range, the cream was up for grabs, but as the dust settled, and the skirl of the pipes pierced the rarefied Glenrowan air, it was Wodonga marksman Brett Thurtell chaired to the presentation area, only dropping one shot for the day. There must be something in the Wodonga air, as Gayle Sewell took out B Grade with a 148.13.

**Day Two Results**

**Target Rifle A Grade**

Brett Thurtell	149.18
Michelle Fletcher	147.19
Rob Richards	147.16

**Target Rifle B Grade**

Gayle Sewell	148.13
--------------	--------



*Aggregate winners with their loot*

Derek Higgins	146.14
Robert Lawler	146.12
<b>Target Rifle C Grade</b>	
Paul Diffey	148.12
Richard McRae	143.1
<b>F Class A Grade</b>	
Jenny Davis	176.13
Garry Warrender	174.12
Graham Crowe	175.8
<b>F Class B Grade</b>	
Jason O'Rourke	176.14
Leigh Metzke	175.8
Kay Eland	174.7
<b>F Class Open</b>	
Spencer Dunstall	179.16
Michelle Giddens	179.11

<b>F Class Target Rifle</b>	
Doug Chalmers	173.11

It is important to remember that this wonderful weekend of shooting has a two-day aggregate, which was won by Gayle Sewell after a remarkably consistent weekend of shooting. Gayle also won the B Grade two-day aggregate.

**Aggregate Results**

<b>Target Rifle A Grade</b>	
Brett Thurtell	322.38
Mark Horsnell	322.36

Pedro Daldy	322.27
<b>Target Rifle B Grade</b>	
Gayle Sewell	323.32
Robert Lawley	316.29
Garry Walton	315.27

<b>Target Rifle C Grade</b>	
Paul Diffey	314.21
Richard McRae	308.24

<b>F Class A Grade</b>	
Garry Warrender	381.25
Graham Crowe	379.20
Joe Melbourne	378.28

<b>F Class B Grade</b>	
Jason O'Rourke	381.23
Leigh Metzke	377.18
Alan Wright	375.2

<b>F Class Open</b>	
Geoff Krake	386.37
Rob Bant	386.25

<b>F Class Target Rifle</b>	
Doug Chalmers	375.22

Many hours of hard work go into running a prize shoot, especially a two-day meet, but seeing so many happy faces and receiving so many positive comments, made every moment worthwhile. The Organising Committee, and every member of the Ovens and Murray Rifle Association hope to see many

familiar and new faces return next years for another fantastic "Easter at Glenrowan."



*Brett Thurtell*



# Rifle news WA

## New Range for 2017 WA Queens Prize

The Western Australian Queens Prize will return to Perth this September, to be held at the long anticipated and newly completed Pinjar range. Set amongst the backdrop of pine forest, the Pinjar range will play host to its first ever Duke of Edinburgh and Queens Prize to the tune of approximately 200 eager competitors.

Off the back of the 2015 and 2016 Queens Prize meets held and hosted by Albany Rifle Club, the new Pinjar range has big boots to fill. The Pinjar complex boasts a modern clubhouse that enjoys views of the range from the control room as well as a large, stainless steel commercial kitchen, bar and canteen, offices, a dedicated rifle cleaning room and function room - plus the WARA Shop operates from here.

The range itself has the capacity to accommodate 24 electronic targets per gallery, from 100 metres to 900 metres (1000 yards). These are housed in the purpose built Target Shed which dominates the south-east end of the complex. The range boasts a single firing point with staggered stop butts - so no more dragging gear from mound to mound!

Pinjar is approximately 42 kilometres from Perth CBD and is situated within the City of Wanneroo. With small garden farms located within the area, it makes for a lovely view on route to the range. However, if more shooting, V8 Supercars or motorbike riding is more your pace, there are the SSAA range, the Barbagello Raceway and motocross tracks located nearby.

For those looking to stay at the range during the Queens Prize, unpowered caravan bays will be available onsite. These must be booked at the time of nomination, prior to the competition. However,



should you be looking for alternative off-site accommodation, there will be information available on the WARA web site ([www.wara.asn.au](http://www.wara.asn.au))

The Duke of Edinburgh lead up commences on Friday September 22, 2017 with the Queens commencing

Saturday 23 until Monday 25 September 2017. Nomination forms and the Program of Events will be available in the ATR magazine, on the WARA web site ([www.wara.asn.au](http://www.wara.asn.au)) or by contacting the WARA office on (08) 9206 5299.

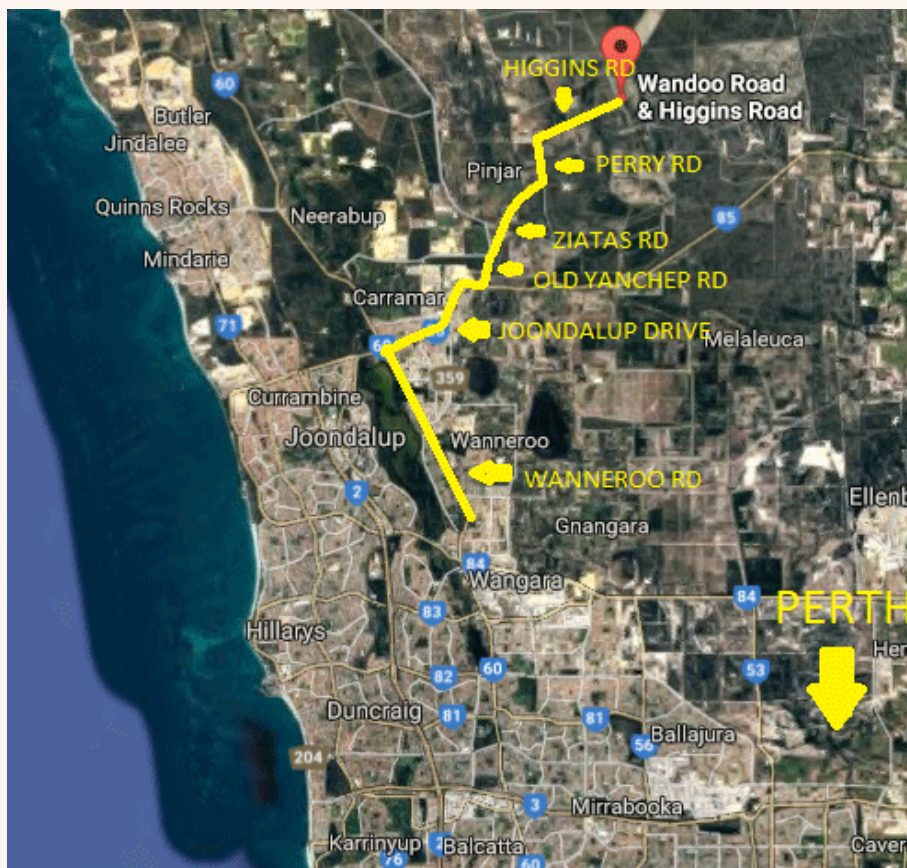



# West Australian Rifle Association Inc.

**108<sup>th</sup> Queen's Prize Meeting**  
**Friday 22<sup>nd</sup> – Monday 25<sup>th</sup> September 2017**  
**Pinjar Rifle Range**  
Corner of Higgins and Wandoo roads, Pinjar, WA 6078

Office Use Only

Entry no: \_\_\_\_\_

## ENTRY FORM

Surname: \_\_\_\_\_ First Name: \_\_\_\_\_ NRAA SID: \_\_\_\_\_  
 Address: \_\_\_\_\_ Suburb: \_\_\_\_\_ State: \_\_\_\_\_ Postcode: \_\_\_\_\_  
 Club: \_\_\_\_\_ Phone: \_\_\_\_\_ Email: \_\_\_\_\_  
 Firearms licence no: \_\_\_\_\_

**Please tick relevant boxes:**

Target Rifle  F Standard  F Open  FTR   
 Veterans  Super Veteran  Under 25   
 (60+ yrs) (70+ yrs)

Officers Cup  TYRO Match   
 (Target Rifle & WA Only) (Target Rifle & FClass)  
 Ex-Services Match   
 (Target Rifle Only)

MATCHES	Entry Fee	Late fee (after 8 <sup>th</sup> Sept 17)	Payment Due
Duke of Edinburgh (Sept 22 <sup>nd</sup> – 23 <sup>rd</sup> )	\$120.00	\$20.00	\$
Queens (Sept 23 <sup>rd</sup> – 25 <sup>th</sup> )	\$160.00	\$20.00	\$
<i>(Payments received after 8<sup>th</sup> Sept 2017 will incur the late fee)</i>		<b>Total</b>	\$

**Camping** – The use of generators will be permitted but there will be a 10.00pm curfew applied.  
 Due to the Department of Environment and Conservation, NO GREY WATER is permitted to run onto the ground.  
 All grey water must be collected and deposited into the drains provided.  
 The complex operates on an Aerobic Treatment System, therefore the use of the facilities provided is recommended as there is no "Dump Facility" available on site. The nearest dump site is approximately 30 minutes away.  
 Non-Powered \$15.00 per site per night Total Nights: \_\_\_\_\_ Total: \$ \_\_\_\_\_

**Payment**

Cheque or Money Order  Cash  Direct Deposit   
 WARA Bank Details:  
 BSB: 633 000 Acc No: 147 069 298  
 Please use your surname as a reference

Please charge my:

VISA  MASTERCARD

Card Number: \_\_\_\_\_/\_\_\_\_\_/\_\_\_\_\_/\_\_\_\_\_  
 Expiry: \_\_\_\_/\_\_\_\_ CCV: \_\_\_\_\_

I understand that the Standard Shooting Rules are to apply throughout this meeting. I certify that I am a financial member of my State Association and NRAA affiliated, and that I am the holder of an appropriate West Australian Firearms License or Temporary Permit (for interstate and overseas visitors).

Signature: \_\_\_\_\_

**Refund Policy**  
 Any entry fees paid shall not be refunded by the West Australian Rifle Association unless written approval of the refund is granted by the Council of the Association. Any application for refund can only be made on the grounds of hardship or unforeseen circumstances and must be submitted in writing for determination by the Council. The decision of Council is final.

**All Correspondence to:**  
 West Australian Rifle Association Inc.  
 PO Box 1559, Wangara DC, WA 6947  
 Email: [eo@wara.asn.au](mailto:eo@wara.asn.au)  
 Phone: (08) 9206 5299

# West Australian Rifle Association Inc.

## Queen's Prize Meeting 2017 Programme of Events The 108<sup>th</sup> West Australian Rifle Shooting Championships



The 108<sup>th</sup> Queen's Prize Meeting is to be conducted at the Pinjar Rifle Range located corner Higgins Rd & Wandoo Rd, Pinjar, Western Australia. This range is a metric range, progressing from 300 metres to 900 metres. The competition is to be conducted using the Division System for Target Rifle and F-Class Standard on electronic targets under NRAA Standard Shooting Rules.

Targets will be allocated to all shooters. A draw will be conducted to determine shooting positions for the Dukes and Queens following the Muster preceding these events.

Start times for each range are a guide only, Competitors must be alert at all times for announcements and notices of any changes

At all ranges, first competitors and scorers will be expected to be ready 15 minutes prior to the allocated start time for each range.

		Target Rifle		F-Class (All Disciplines)	
		Duke's	Start Time	Duke's	Start Time
<b>Friday Range</b>	<b>1</b>	300	8:00	500	8:00
	<b>2</b>	400	10:45	500	10:45
	<b>3</b>	500	13:30	600	13:30
	<b>4</b>	600	15:45	800	15:55
<b>Sat AM Range</b>	<b>1</b>	600	8:00	800	8:00
	<b>2</b>	800	10:25	900	10:35

		Target Rifle		F-Class (All Disciplines)	
		Queen's	Start Time	Queen's	Start Time
<b>Sat PM Range</b>	<b>1</b>	300	13:30	500	13:30
	<b>2</b>	500	15:45	600	15:45
<b>Sun Range</b>	<b>1</b>	600	8:00	700	8:00
	<b>2</b>	600	10:15	700	10:25
	<b>3</b>	700	13:00	800	13:00
	<b>4</b>	700	15:25	800	15:35
<b>Mon Range</b>	<b>1</b>	800	8:00	900	8:00
	<b>2</b>	900	11:15	900	11:15

WARA Champion of Champions Shoot off at 600 metres in middle of Range commencing 13:45

**PLEASE BE ADVISED:**  
**Nominations for the WARA Dukes and Queens will close at 5:00 pm Friday 8<sup>th</sup> September**



# Easter Prize Meeting - 2017

Article and photographs by  
George Wittorff

The 2017 Easter SWDRA Easter Prize Meeting was attended by 50 marksmen and women from clubs across the state, ranging from Karratha, Leonora and Esperance, and marked the resumption of this competition following a two-year hiatus due to stop butt repairs. The weekend's shooting comprised the shooting of the Coolilup Cup; a one day competition over three ranges; followed by the South West DRA Open Championships over two days.

## Coolilup Cup

Shot over 300, 500 and 600 metres, in fine but cloudy conditions, this year's Cup was won by multiple former winner, John Moore from Leonora, followed one point behind by target rifle shooter Mark Milentis of Manjimup. Busselton's Graham Oates took out the F Standard division, just 4 X's in front of Mal Hamilton of South Perth. F Open was won by Busselton shooter Brad Yates, a clear point ahead of Boddington's Bob Kinnear.

## South West DRA Open Championship and Service Rifle

The South West DRA Open Championships is a two-day event,



John Moore - TR winner of SWDRA Championships with MP Nola Marino

fired over all distances from 300 metres - 900 metres. Visitors to the range would have noticed the warm and sunny skies accompanied by a pleasant light breeze. While these seemingly benign conditions appeared conducive to good shooting conditions, it was clear to the shooters on the mound that there was a very tricky mirage showing through the spotting scopes and telescopic sights. These

conditions tended to intensify as the day moved on, resulting in the mirage moving from left to right; right to left; and boiling; causing all shooters to read the conditions carefully and trust their judgement. Not surprisingly, there were many frustrated and disappointed shooters over the two days. Of course, the top scorers tended to be the more able condition readers who were also able to get shots away quickly in order to avoid changing mirage. Day one aggregate top scorers were, in target rifle John Moore, who scored the maximum of 200, with 22 centre bulls eyes. The division two winner for the day was Tony Schlink on 195.13 and division three was taken by Graeme Turner with 195.17. F Class Standard A saw Mal Hamilton lead with a creditable 236.20, with F Class Standard B seeing newcomer Anthony Penny from Darling Range shoot a score of 235.16. Wily Bob Kinnear top scored for F Open with a hit of 238.20. Day two carried on from the Saturday, with conditions making the long ranges of 700 metres, 800 metres and 900 metres testing to say the least.



John Moore - Winner of the Coolilup Cup TR



Continued from page 39

John Moore, once again showed his prowess in testing conditions to win the day for target rifle, dropping just two points at the 900 metres and scoring a daily aggregate of 148.11. Division two was won by Kerry Samuel with 140.9 and division three by Colin Dods on 145.12. In F Standard, A group's top scorer for the day was Graham Oates on 171.11, with B group top scorer being Anthony Penny, recording 168.11. Rod Rees took honours for F Open with 176.13. The final outcome saw the following shooters as winners for the SWDRA



Michelle Small (Esperance) Winner of FTR

Open Prize Meeting:

**Results**

**Target Rifle:** John Moore of Leonora: 348.33

**F Standard:** Mal Hambleton 406.28

**F Open:** Rod Rees 412.24

**FTR:** Michelle Small 163.6

**Life Membership Awards**

Following the daily aggregate presentations on Saturday, SWDRA Life Membership Certificates were awarded to Ken Sue and Dave Basten, both of Busselton Rifle Club. Both men have made considerable contributions to the South West Association and their awards were richly deserved. Keith Sadler and Rod Davis made short speeches paying tribute to Ken and Dave. In addition, Ken Sue received his WARA 50 Year Membership Certificate.

**Service Rifle:**

The SWDRA has a strong and regular Service Rifle competition



Mal Hambleton (South Perth) Winner SWDRA F Std



Brad Yates (Busselton) Winner of F Open in Coolilup Cup

run throughout the year, and it has been the custom over the past six or so years to incorporate a Service Rifle Championship within the Easter Shoot. This is achieved by having the Service Rifle shoot on the Friday's Coolilup Cup shoot over 300, 500 and 600 metres, and then again on the first day of the Open Championship over 300, 400, 500 and 600 metres.

Eight competitors fronted for this competition and it is gratifying to see shooters who enjoy shooting unmodified service rifles over the short ranges.

The first day's shooting was won by Frank Kocsis with a score of 141.11, followed by Jack Nixon on 138.9. Day two belonged to Jack Nixon who came home on a score of 182.8, followed by Julien Davey on 177.6.



Jack Nixon (Busselton) Winner of Service Rifle Championship

The overall placings for the South West DRA Service Rifle Championship were: Jack Nixon (1) 320.17, Frank Kocsis (2) 313.21, then Julien Davey (3) on 301.12.

**Results:**

**South West Clubs: Coolilup Range: Coolilup Cup**

**Aggregate: TR:** J Moore 149.18; M Milentis 148.16; L MacKay 148.12; I Syme 145.17; M Watts 145.8: **Div 2:** K Sue 145.8; C Dods 144.9; R Taylor 144.8; G Wittorff 143.7; Chris Dods 143.6: **F Std A:** G Oates 178.19; M Hambleton 178.15; M Reid 174.16: **F Std B:** M Small 174.8; N Carver 171.7; A Penny 170.7: **F Open:** B Yates 179.17; B Kinnear 178.14; R Burton 177.16; C Day 176.16: **Service Day 1:** F Kocsis 141.11; J Nixon 138.9; J Hohnen 128.7:

**SWDRA Championship:**

**Day One Aggregate: TR:** Div 1: J Moore 200.22; M Milentis 198.16;



Ken Sue and Dave Basten with SWDRA Life Membership Certificates



Rod Rees (Beverley) Winner of SWDRA Championship F Open with Nola Marino

I Syme 197.17; D Felton 195.17; L Felton 194.17; Div 2: T Schlink 195.13; G Wittorff 193.18; A Dods 191.18; M Watts 191.10; Chris Dods 189.10; Div 3: GD Turner 195.17; C Dods 193.17; A Trease 188.13; D Kuffer-Barillet 185.12; K Sadler 183.8; **F Std A:** M Hambleton 236.20; M Reid 235.22; G Oates 231.17; C Keogh 2231.14; **F Std B:** A Penny 235.16; R Lydia 231.16; J Neilsen 222.10; N Carver 218.7; **F Open:** B Kinnear 238.20; R Rees 236.21; R Hurley 235.21; B Day 233.13; **FTR:** M Small 226.13; **Service:** J Nixon 182.8; J Davey 177.6; F Kocsis 172.10; J Hohnen 172.2:

**Day Two Aggregate: TR:** Div 1: J Moore 148.11; D Felton 146.11; L MacKay 143.10; Div 2: K Samuel



Graham Oates (left) winner of F Std in Coolilup Cup with Mark Milentis (SWDRA Chairman)



Service Rifle shooters in action



F Class and Target Rifle shooters

140.9; G Wittorff 138.11; A Dods 138.11; Div 3: C Dods 145.12; D Kuffer-Barillet 142.7; G Turner 142.7; **F Std A:** G Oates 171.11; M Hambleton 170.8; C Keogh 169.9; **F Std B:** A Penny 168.11; C Le May 168.7; R Lydia 166.5; **F Open:** R Rees 176.13; B Day 174.7; B Kinnear 173.12; **FTR:** M Small 163.6:

**SWDRA Championships:** **TR:** Div 1: J Moore 348.33; Div 2: G Wittorff 331.29; Div 3: C Dods 338.29; **F Std A:** M Hambleton 406.28; **F Std B:** A Penny 403.27; **F Open:** R Rees 412.34; **FTR:** M Small 389.19; **Service Rifle:** J Nixon; **Closed Champion:** M Milentis 339.28; **Open Badges:** **TR:** J Moore (1) 348.33; D Felton (2) 341.28; M Milentis (3) 339.28; C Dods (4) 338.29; I Syme (5) 338.28; G Turner (6) 337.24; L MacKay (7) 337.21; **F Std:** M Hambleton (1) 406.28; A Penny (2) 403.27;

G Oates (3) 402.28; C Keogh (4) 400.23; **F Open:** R Rees (1) 412.34; B Kinnear (2) 411.32; **FTR:** M Small 389.19; **Service Rifle:** J Nixon (1) 320.17; F Kocsis (2) 313.21; J Davey (3) 301.12.



Mal Hamilton (South Perth) Winner of SWDRA F Standard with Hon Barry House MLC

# Hartley Rifle Club Target

Article and photos

by Jim Caspers

At the recent State Championships at Lower Light, the South Australian Rifle Association unveiled the restored Hartley Rifle Club target



donated to them in late 2016. The restoration work and mounting was undertaken by Cold Logic Pty Ltd, industrial refrigeration experts, of Port Adelaide.

The Salem (German) Rifle Club was formed around 1880 and fired on the range set up on Mr T Jaensch's property at Salem. The Club ran its own Kingship (Open Prize Meeting) and club members participated

at other Kingships run by clubs throughout the Adelaide Hills.

The target used was a cast iron disc with 10 scoring rings and a steel centre piece with a further three scoring rings. The centre ring (worth 13 points) was reported to be about the size of a five shilling piece (38 mm). The distance fired was 200 yards.

In 1894, the club shifted its range to Mr H Harvey's property at Hartley and the club name changed to Hartley Rifle Club.

The first competition for the Hartley Rifle Club was held on November 5, 1894 and was won by Mr CH Hutson, who for his five shilling entry fee won the princely sum of eight shillings and six pence.



The Club continued competitions until at least 1901, when the last newspaper report on the club can be found. Members of this club also joined the Murray Bridge Defence Rifle Club (which had sub-branches at Callington and Monarto), with Mr BA Stein and Mr JB Sanders both becoming Murray Bridge club champions.

The target was rescued, after being partly buried for some years on the farm property of Max S Samuels at Hartley, by Dr Allan Robertson, Terry Brown and Bryan Robertson. Unfortunately, the steel centre piece has been lost. We thank all of the people involved in preserving a piece of our sporting history.



## S.A.R.A. News

From the Executive Officer's Office

SARA would like to thank everyone who helped in preparing the range, organising and running of the Queens. Once again it was a very successful event with lots of fun and good shooting had by all.

### EAST v's WEST COMPETITION

Nominations for captains, coaches and shooters for Target Rifle and F Class for the East v's West competition will be called for shortly. It will be held on October 29, 2017.

### SARA AGM

The SARA AGM will be held during the lunch break at the East v's West competition, October 29 2017.

### SARA Store

SARA is in the process of developing an EStore. Stay tuned for a new and easy shopping experience. In

the meantime, you can browse our stock list on <http://www.riflesa.asn.au/shop.htm>. Please contact us if you have any enquiries. Email [shop@riflesa.asn.au](mailto:shop@riflesa.asn.au)

### SARA website

For all current information please see our website <http://www.riflesa.asn.au/>

### Club Chits

A reminder to members that when you are renewing your Firearms Licence or registering a firearm, you need to send a Club chit with your application. Chits are available from your club secretary.

### New Members

Welcome to the following new members: Aiden Brentson, Murray Bridge; Leigh Goodman, Kapunda and Ronald Burnett, Whyalla.

# Fathers and Sons Matches 2017

By Frank Pinyon

Fifty shooters made it up to Mount Barker in the Adelaide Hills for the annual Fathers and Sons competition this year. This included eight members of the Bradshaw family and surprise, surprise they took away most of the trophies with all of them featuring in the listings.

The main target rifle trophy for the off rifle Father/Daughter pair was won for the seventh time by Phil Bradshaw and Lynlee Lowe with 157.13 out of a possible 160. Phil was also second with his other daughter Bronwyn just three centres behind.

The 'Frank Bradshaw Memorial' for the F Standard 'Fathers and Sons' trophy was won by Robert and Thomas Mousley with 176.7 from Rob and his daughter Kerryn.

In F Open, Paul Bartel and son Dean were winners of the 'Braund Family Shield' for the first time;

finally breaking the Braund hold on this trophy since its inception.

The SARRE Cup for handicap was won by Phil Bradshaw and Bronwyn Hajek.

The 'Husband and Wife' trophy was won by Phil and Helen Bradshaw.

Bronwyn Hajek and niece Jessica Lowe won the "In-Laws" trophy with this being the first shoot at Fathers and Sons for Jessica. The "Brother's Trophy" was won by Lynlee and Bronwyn; and the "Self Handicap" was won by Phil and Brad Hajek.

Grandpa Phil also won the Grandparent/Child trophy with Rachel Hajek who, like her cousin Jessica was making her first Fathers and Sons appearance.

Off rifle trophies for the "Bleasdale Cup" in target rifle was Lynlee Lowe with 79.7, the F Open Medal for top off rifle was awarded to



Stuart Braund with 95.6 and the F Standard top score for the day was Jim Caspers with 91.5 who dragged his brother Larry out of retirement for a Fathers and Sons re-union. This also gave Jim the Veterans trophy.

The Ex-serviceman trophy was won by another of the Bradshaw clan with Andrew Lowe scoring 87.3.

Jacinta Blackmore also made her first visit to Fathers and Sons with dad Danny and went away with the Juniors trophy with a score of 85.2.

The Open Pairs for F Class was won by Ron Hatton and Nunzio Sapio with 178.4. while Gordon Harrison and Andrew Heard won the target rifle open pairs with 149.6.

The shoot off in each discipline to determine the "Anzac Day Medal" winners was closely contested in each category. The match is open to all competitors on the day with the top four target rifle, top four F Standard and top four F Open shooters going head to head for the three Anzac Day medals. Frank Pinyon won the target rifle medal. The F Open medal was won by Ron Hatton and the F Standard medal was won by Jim Caspers.

It was a great day and a big thanks must go to the Mt. Barker members and ladies for their help in running the shoot and providing the range; as well as Ron Hatton who donated an Anzac Day Commemorative Bear that was raffled at the end of the day.



The Bradshaw Clan. L to R - Phil Bradshaw, Helen Bradshaw, Lynlee Lowe, Bronwyn Hajek, Brad Hajek, Andrew Lowe. Front - Jessica Lowe and Rachel Hajek.

# North Arm .303 Military Rifle Competition

By Bob Bull – .303 Competition Organiser and  
Grant Larsen – NARC Secretary

Photos by  
Gordon Collie

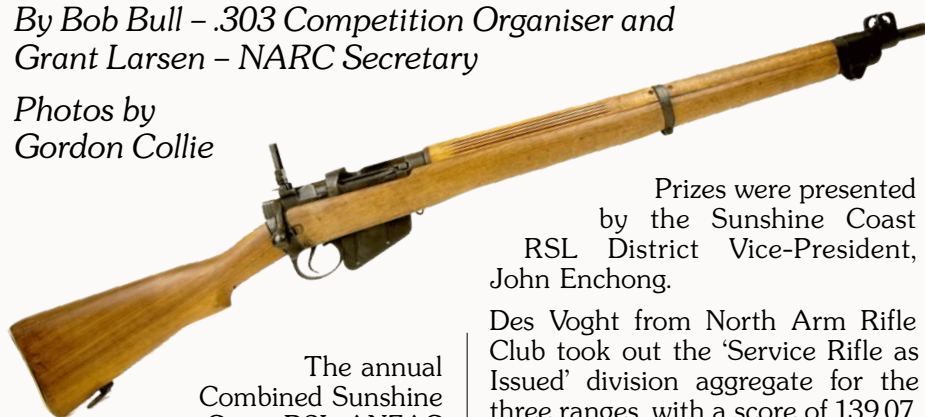

Prizes were presented by the Sunshine Coast RSL District Vice-President, John Enchong.

Des Voght from North Arm Rifle Club took out the 'Service Rifle as Issued' division aggregate for the three ranges, with a score of 139.07.

The Modified Service Rifle division aggregate was won by Bob Crawford from Gympie/Kilkivan with an excellent score of 150.12.

The Service Modified Scope Rifle

The annual Combined Sunshine Coast RSL ANZAC Memorial .303 Military Rifle Competition 2017 was conducted by North Arm Rifle Club (NARC) at their Davison Range Target Sports complex on Sunday April 23, 2017.

Supporting RSL clubs had representative teams participating which saw a total of 33 shooters competing for an impressive range of trophies.

Competitors shot ten-shot matches over 300 metres, 400 yards and 500 yards with excellent conditions and some very good scores.

Shooters nominated in one of four divisions - Service Rifle as Issued, Modified Service Rifle, Service Modified Scope Rifle and RSL Division, as well as an overall Team competition. The 'one-up' scoring system was used to score each range.



Service Rifle winner Des Voght, North Arm



For Slider -- Jessica Crawford, Gympie

division aggregate was won by Riley Crawford from Gympie/Kilkivan with an aggregate of 148.14.

The winner of the RSL aggregate division was Ben Pullin of Caloundra RSL with a score of 142.07.

The Bruce Bingham Memorial Trophy for the highest Grand Aggregate for a Modified Service Rifle was won by Bob Crawford.

Peter Richards from QMRC won the trophy, sponsored by the Cooroy Hotel, for the highest V-bull count of 17 V-bulls.

The Nambour RSL Sub-Branch Perpetual Trophy for the RSL Teams Event was won by the Caloundra RSL Number two team. The Caloundra team was made up of George Sedgewick, Ben Pullin and Jack Watson.

The team from Gympie/Kilkivan won the NARC Teams Event trophy. Members of the winning team were David Hatherell, Bob Crawford, Riley Crawford and Jessica Crawford.

**Results are as follows:**

## 300 metres:

Service Rifle as Issued		
1.	Des Voght (North Arm)	49.02
2.	Peter Wicks (North Arm)	44.03
3.	Rod Wood (QMRC)	42.03

Modified Service Rifle		
1.	Glen Skipworth (QMRC)	50.07
2.	Bob Crawford (Gympie/Kilkivan)	50.05
3.	Peter Richards (QMRC)	49.05

Service Modified Scope		
1.	Riley Crawford (Gympie/Kilk)	48.03
2.	Tegan Hinricks (Wondai)	42.01
3.	John Hinricks (Wondai)	39.02

RSL		
1.	Ben Pullin (Caloundra)	45.03
2.	George Sedgewick (Caloundra)	44.00
3.	Jack Watson (Caloundra)	42.02

## 400 yards:

Service Rifle as Issued		
1.	Garry Henderson (Natives)	47.02
2.	Des Voght (North Arm)	46.02
3.	Rod Wood (QMRC)	45.01

Modified Service Rifle		
1.	Peter Richards (QMRC)	50.07
2.	Bob Crawford (Gympie/Kilkivan)	50.06
3.	Shane Kao (Darling Downs)	50.06



Mark Guy who shot in the Caloundra RSL team



Jimmy Wardell, Gympie-Kilkivan



QMRC members Adam Hanley and Iaan McMillan



Bob Crawford, Gympie-Kilkivan



George Sedgewick, Caloundra RSL with range officer Grant Larsen

**Service Modified Scope**

1.	Riley Crawford (Gympie/Kilk)	50.06
2.	John Hinricks (Wondai)	48.03
3.	Tegan Hinricks (Wondai)	38.01

**RSL**

1.	Ben Pullin (Caloundra)	48.04
2.	Michael Hogan (Caloundra)	47.03
3.	George Sedgewick (Caloundra)	47.00



Continued from page 45

**500 yards:**

**Service Rifle as Issued**

1.	Rod Wood (QMRC)	45.03
2.	Des Voght (North Arm)	44.03
3.	Garry Henderson (Natives)	40.00

**Modified Service Rifle**

1.	Jessica Crawford (Gympie/Kilk)	50.04
2.	Bob Crawford (Gympie/Kilkivan)	50.01
3.	Bob Bull (North Arm)	50.01

**Service Modified Scope**

1.	Riley Crawford (Gympie/Kilk)	50.05
2.	John Hinricks (Wondai)	47.05
3.	Greg Pullin (RSL)	40.00

**RSL**

1.	Ben Pullin (Caloundra)	49.00
2.	David Cairns (Caloundra)	44.01
3.	Jack Watson (Caloundra)	43.00

Special thanks was directed to the many volunteer workers and markers from North Arm Rifle Club for their work on the day.

Special mention and thanks to our sponsors for their financial support of the competition goes to:

Bingham family

Caloundra RSL Sub-branch

Cooroy Hotel

Cooroy-Pomona RSL Sub-branch

Maroochy RSL Club



Ben Pullin, Caloundra RSL



Lachlan Davis, QMRC with Jim Breeze, Darling Downs



Peter Richards and Glenn Skipworth, QMRC



Gympie Kilkivan youngsters Jessica and Riley Crawford who both shot possibles at 500 yards



# Clermont Rifle Club OPM

By Margy Kerlin

The Clermont Rifle Club hosted its annual Open Prize Meeting on May 6-7. Thirty-eight shooters from as far afield as Cairns and West Wallsend enjoyed balmy weather - with moderate conditions, mirage and gusting wind testing the skills of all. Our life member Merv London was unable to attend the Open Prize Meeting this year due to serious illness. Merv passes on his best wishes to all.

The A Grade aggregate came down to the line with local Clermont shooter, Anthony Wilson 295.32 taking the honours from fellow club member Carol Solomon 295.28 and Charles Arrowsmith (Biloela) on 291.21.

Rex Waite (West Wallsend) 290.20 did battle with Max Bidgood (Crows Nest/Goombungie) 289.24 and Gareth Steward (Sarina) 284.25, for the B Grade aggregate, and Gavin Williams from the Gemfields Club took out the C Grade aggregate with 267.10.



Clermont OPM 2017 competitors

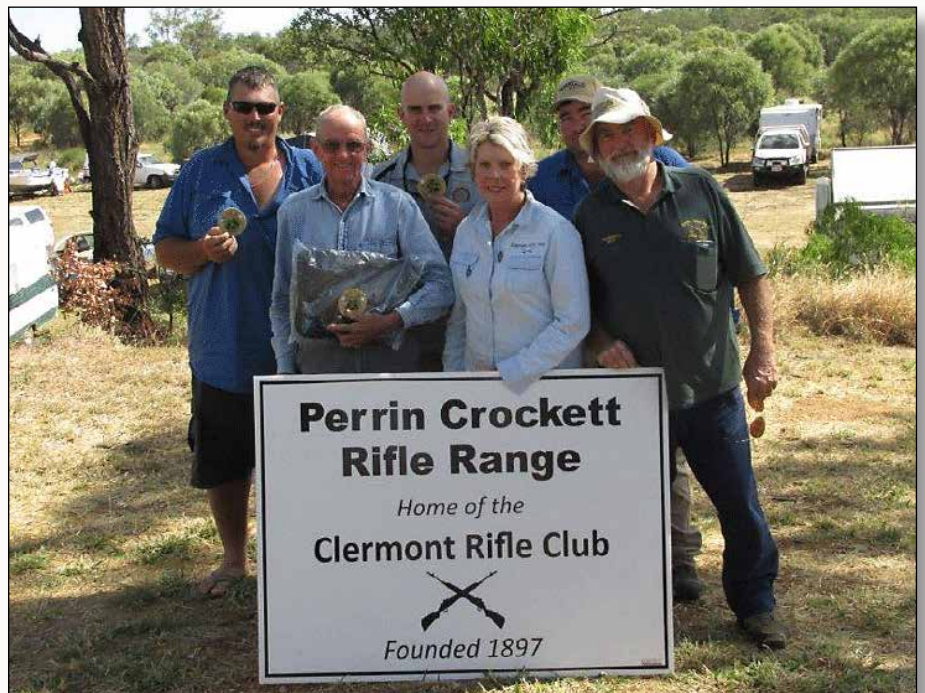

Grand Aggregate Winners – Back row L-R Gavin Williams (C) Anthony Wilson (A) Terry Hancock (FO). Front Row - Jim Blomfield (FA) Margy Kerlin (FB) Rex Waite (B)



It's a family sport – Marty (shooter) and daughter, Imogene (Tiger Marker) Eiteneuer

F Standard A Grade saw the old master Jim Blomfield (Bowen-Collinsville) 345.21 take out the title with Nick Williamson (Gemfields) in second place on 344.21 and Noel (Bear) Byrne (Clermont) 337.14, in third place.

In F Standard B Grade, local Clermont shooter Margy Kerlin took out the aggregate with 335.14. In second place was Joe Koch (Monto) with 328.16 and in third was Chris Murray (Gemfields) 328.14.

F Open was a tussle between Terry Hancock (Central Qld Target Sports) 349.28 and Gary Towers (Bundaberg/Burnett) 344.22

with Rebekah Scotney from the Gemfields in third place on 301.11.

The rumour was on Sunday morning that a 'Tiger' had been spotted on the range. Investigation revealed that indeed it was true and young Imogene Eiteneuer, dressed in her finest "tiger onesy" pyjamas had reported for her marking duties.. it was a little cool on Sunday morning!

All in all, good shooting, good food and good company was the order of the weekend and the Clermont Rifle Club extends our thanks to everyone that helped make it happen. We look forward to seeing you all next year.

# Double for Darren at Bundaberg

Article and photos by  
Gordon Collie

Australian representative shooter Darren Enslin showed his class in collecting a trophy double against high quality competition at the 2017 Bundaberg Burnett Rifle Club Open Prize Meeting.

The Pacific Rifle Club member posted the only possible 200 score, hitting all 40 bullseyes over four ranges from 300 to 600 yards on Saturday, June 3.

He was narrowly beaten in two 15 shot rounds at 900 yards in challenging headwind conditions on day two. Gordon Duncan from Brisbane Central clinched the Sunday aggregate by two centre bulls, 145.15 to 145.13.

Darren secured the grand aggregate trophy for the weekend, two shots clear of Maryborough's Rodney Prayle with Ashley Bidgood from Crows Nest a shot back in third place.

Darren was a member of the Australian team which competed in South Africa in March and has been appointed captain of the national team being assembled for the next World Championships which will be held in New Zealand in early 2019.

The Bundaberg Open attracted a strong field of competitors from around Queensland with shooters



Darren Enslin and his son Dean

from Western Australia and South Australia also attending in the lead-up to the Australian Queens Prize Match scheduled in Brisbane late in June.

Bundaberg Club Captain Maurie Irwin was a clear winner of the B Grade competition with young Gympie shooter Jessica Crawford turning in a dominant performance to clean sweep C Grade.

Nick Williamson from the Gemfields Rifle Club finished on top of the strong F Standard class events with Dave Boreham from North Arm winning the F Open competition.

A .303 series shot in parallel over the weekend attracted seven shooters with the clear winner being Anthony Wilson from Clermont.

## Bundaberg Day One

### Aggregate:

**A Grade:** Darren Enslin, Pacific, 200.19, Ashley Bidgood, Crows Nest, 199.23, Rodney Prayle, Maryborough, 198.26.

**B Grade:** Maurie Irwin, Bundaberg, 193.12, Bob Skelton, City of Brisbane, 191.12, Russell Saxby, Goondiwindi, 191.9.

**C Grade:** Jessica Crawford, Gympie, 192.12, Josh Turner, Bundaberg, 184.10, Bruce Nardi, Pacific, 177.6.

**F Standard A Grade:** Andrew McKillop, Bundaberg, 234.16, Nick Williamson, Gemfields, 234.15, Mahlon Reid, Boddington, 233.20.

**F Standard B Grade:** Tim Riddle, North Arm, 228.16, Peter Drew, Brisbane, 227.7, Ken Martin, Bundaberg, 222.12.

**F Open:** Dave Boreham, North Arm, 237.18, Scott Mitchell, Bundaberg, 236.24, Steve Nelson, Beaudesert, 235.20.

**F Target Rifle:** Frans Knox, Brisbane, 228.15, Bob Steel, Crows Nest, 222.11.

**.303 Match:** Anthony Wilson, Clermont, 174.7, Dave Hatherell, Gympie, 167.5, equal Josh Turner and Len Miller, 164.4.



Nyree Cislowski, Bundaberg and Emily Cronin, Clermont



WA visitors, Micheal Green, Kambalda, Paul Watkins, Chapman Valley, Michael Reid, Boddington, and David Cole, Yarloop



Kaye Skelton, City of Brisbane and Bevan Gossnick, Monto

**Day Two Aggregate**

**A Grade:** Gordon Duncan, Central, 145.15, Darren Enslin, 145.13, Paul Watkins, Chapman Valley, 145.12.

**B Grade:** Equal first Dennis Bidgood, Crows Nest and Maurie Irwin, Bundaberg, 137.7, Emily Cronin, Clermont, 137.4.

**C Grade:** Jessica Crawford, 134.5,

Chris Abbott, Bundaberg, 124.5, Josh Turner, Bundaberg, 124.3.

**F Standard A Grade:** Nick Williamson, Gemfields, 170.10, David Hatherell, Gympie, 170.9, Andrew McKillop, Bundaberg, 168.9.

**F Standard B Grade:** Kristine Crawford, Gympie, 162.13, Tim Riddle, North Arm, 160.8, Ken Martin, Bundaberg, 157.5.

**F Open:** Graham Sells, Dalby, 174.11, Dave Boreham, North Arm, 173.9, Colin Sutton, Goondiwindi, 173.6.

**F Target Rifle:** Bob Steel, Crows Nest, Frans Knox, Brisbane, 151.5.

**.303 Match:** Trevor Rock, Darling Downs, 111.3, Anthony Wilson, Clermont, 106.5, Dave Hatherell, Gympie, 95.3.

**Grand Aggregate**

**A Grade:** Darren Enslin, Bundaberg, 345.32, Rodney Prayle, Maryborough, 343.37, Ashley Bidgood, Crows Nest, 342.37.

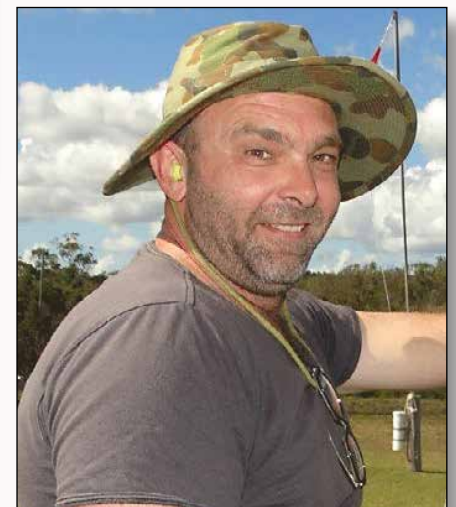

Tim Riddle, North Arm

*Continued from page 49*

**B Grade:** Maurie Irwin, Bundaberg, 330.19, Emily Cronin, Clermont, 327.20, Malcolm Flavel, Whyalla, 325.22.

**C Grade:** Jessica Crawford, Gympie, 326.17, Josh Turner, Bundaberg, 308.13, Bruce Nardi, Pacific, 299.7.

**F Standard A Grade:** Nick Williamson, Gemfields, 404.25, Andrew McKillop, Bundaberg, 402.25, Dave Hatherell, Gympie, 397.18.

**F Standard B Grade:** Tim Riddle, North Arm, 388.24, Ken Martin, 379.17, Peter Casley, Murray Bridge, 376.13.

**F Open:** Dave Boreham, North Arm, 410.27, Graham Sells, Dalby, 408.25, Graham Mincham, Bundaberg, 407.28.

**F Target Rifle:** Bob Steel, Crows Nest, 389.19, Frans Knox, Brisbane, 379.20.

**.303 Match:** Anthony Wilson, Clermont, 280.12, Trevor Rock, Darling Downs, 273.6, Dave Hatherell, Gympie, 262.8.



*Jenny Steel and Cheryl Bidgood, Crows Nest Goombungee*

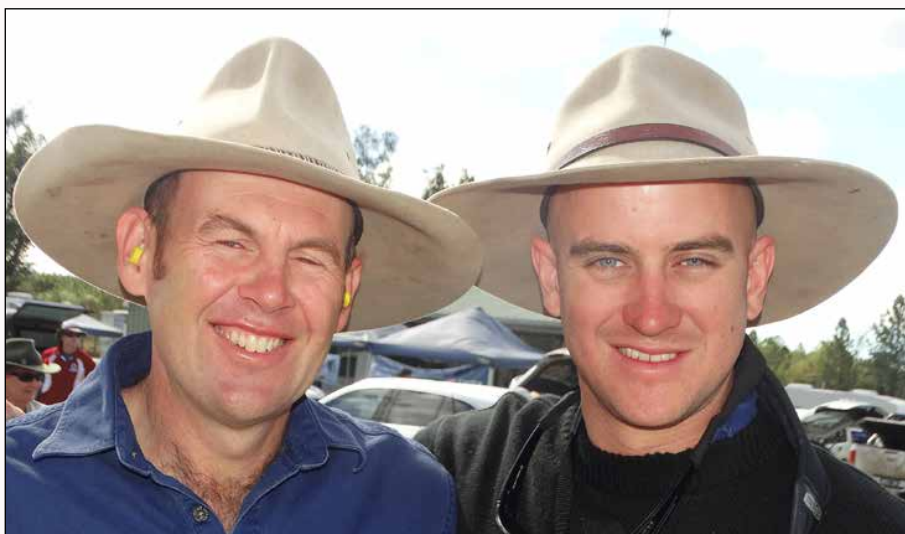

*Ken Cislowski, Bundaberg with Anthony Wilson, Clermont*



*Nick Williamson, Gemfields*

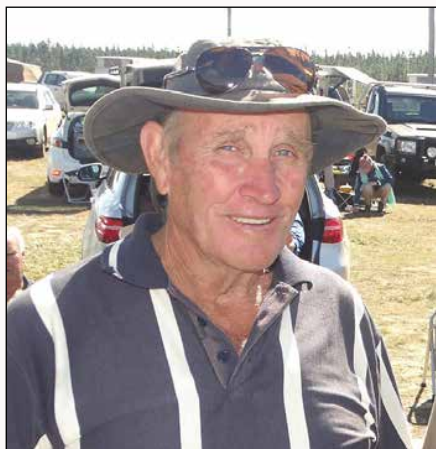

*Kevin Rayner, Bundaberg*



*Noel Hoopert and Maurie Irwin, Bundaberg*

# Vale Adrian Hobbs

1932 - 2017



It is with sadness and disbelief I report the sudden death of South Australia's longest participating member, Adrian Hobbs (joining in 1948 at the age of 16).

Adrian passed away quietly and quickly in the presence of his family at the Royal Adelaide Hospital on Friday April 28 (the day after his 85th birthday), after being diagnosed with aggressive leukaemia only days earlier.

It is difficult to believe that only the week prior he lamented there had not been time to reassemble his 5.56 in time for Saturday's shoot.

Adrian was born in Maylands, Adelaide on April 27, 1932 to Florence and Arnold.

He married Joan in 1953 and as an electrician soon moved from Adelaide to the South Australian countryside. Firstly, he moved to Port Augusta and joined their Rifle Club. A few years later saw another move to Berri and the Barmera rifle Club. Some more years and their final move was to the Morgan district where he served as the Superintendent of the Morgan-

Whyalla pipeline for the Engineering and Water Supply Department of the South Australian Government until retirement in 1989. During this period Adrian belonged to the Goodwood United Rifle Club at the Dean Rifle Range; some 160 kilometres from home.

Following the Dean Range closure, he joined the Waikerie Rifle Club and remained their solitary prone shooter to the very end.

In 1968, he joined the Morgan Smallbore rifle club - fulfilling every role the Club could offer and an integral member contributing to the Club's success and survival. Only in recent years did he succumb to the Scope and Bench Rest mantra with the .22.

Certainly, fullbore target shooting was his passion and dedication reaps its rewards, as success was no stranger.

In 1951, aged 19 he gained selection with the South Australian State Team, followed by an additional 13 selections; the last in 1989.

Additionally, during this period he was

selected by the NRAA to compete at Bisley, Canada and New Zealand with the Australian Team.

At the personal level, the highlights have to be number one badge at SARA's 1963 and 1966 Queens while a member of the Barmera Rifle Club.

The trophy cabinet is not shy of content and ashamedly the number of Queens badges has not been counted, but conservatively must number greater than 60.

In later times, team shooting came to the fore once again with the South Australian Veterans Rifle Association. He was selected on two occasions, representing Australian Veterans teams competing in South Africa and Perth.

Adrian was President of South Australian Veterans for ten years and was recognised last year with Life Membership.

Without doubt team shooting was his predilection - always keen to promote and participate - a component that he was happy to share.

Naturally there were other activities: cars, tennis, gardening and fishing. In his youth, he learnt to play the Piano Accordion, and as years advanced the skill correspondingly diminished, however it was a potent tool to nudge visitors who might just be staying a bit too long.

In recent years the annual trip to Tumby Bay became a firm favourite - shooting and fishing with Gordon and Margaret Harrison, how good can it get?

Adrian was simply the epitome of the dedicated shooter; indifferent scores or stray shots were simply not tolerated. It simply meant another theory or trip to the lathe was necessary to rectify the matter. Many a rifle stock surrendered its life to the persistent whittling and reshaping.

Adrian is survived by Joan, daughter Deborah, sons Garry and Roger, Son-in-law Henry, two grandchildren and three great grandchildren.

A sad loss to his family, numerous friends scattered throughout Australia and the shooting fraternity.

Gone, but never forgotten.

**ACT**

**November**  
15-19 ACT Queens

**NEW SOUTH WALES**

**July**  
2 West Wallsend OPM (Cessnock)  
8-9 DRA Weekend including Country v City C of C, DRA TEAMS (Anzac)  
10-14 Schools practice practice (Anzac)  
15 All Schools Teams (Anzac)  
23 Josephson Teams (Hornsby)  
tba Ungarie Sweepstks and prize meeting OPM (Ungarie)  
**August** 15-19 QRA Queens (Belmont)  
20 Explorers Rifle Club OPM (Lockhart)  
Narromine-Dubbo Rifle Club OPM (Narromine-Dubbo)

**September**  
13-17 NSWRA 141st Open Championships Queens (Anzac)

**October**  
30-1 Coonabarabran Rifle Club OPM (Coonabarabran)  
Ultra long distance  
1000yds - 1500yds Event (Coonabarabran)  
Eugowra OPM (Eugowra)  
Cootamundra OPM (Cootamundra)  
15 Gosford OPM (Kariong)  
22 Bathurst OPM (Bathurst)

**November**  
4-5 North Shore DRA 2 day OPM (Hornsby)  
10-14 Aust Match Rifle and Long Range Champs (Stawell)  
15-19 ACT Open Championships Queens (Canberra)  
Coffs Harbour Rifle Club Field/Rimfire OPM (Dairyville)

**December**  
Lithgow Rifle Club OPM (Lithgow)

**QUEENSLAND**

**July**  
2 Beaudesert Rifle Club PM  
8-9 Monto Sweepstake Shoot  
14-17 Central Qld Championships (rescheduled from 14-17 April)  
30 Ipswich & District Rifle Club PM

**August**  
12 Brisbane Rifle Club PM  
13 MDRA PM  
15-16 QRA Duncan Series  
17-19 QRA Queen's  
26-27 Gemfields Rifle Club PM

**September**  
1-3 Goondiwindi Rifle Club PM  
2-3 Barcaldine Rifle Club PM  
14-18 NSW RA Lead-up & Queen's  
16-17 Billy Sing Marksman Shoot (Clermont)  
22-25 WA Queens "South Burnett DRA PM - Wondai

**October**  
28 North Arm Rifle Club PM  
29 Lilley DRA PM

**November**  
15-19 Canberra Queens  
25-26 Darling Downs Rifle Club PM

**December**  
9-10 Raglan Christmas Shoot

**NORTH QUEENSLAND**

**July**  
15-16 Cairns Prize Meeting (Wangetti Range, Cairns)

**August**  
5-6 NQRA Pennants (HRSC, Townsville)

**September**  
2 C&IDRA Prize Meeting (Atherton Range)  
3 Atherton Prize Meeting (Atherton Range)  
15-16 NQRA Club Teams (HRSC, Townsville)

**October**  
1 Ravenshoe/Mt Garnet Prize Meeting (Ravenshoe)

**SOUTH AUSTRALIA**

**July**  
1-2 Loxton OPM (Loxton)  
15-16 West Broken Hill (West Broken Hill)  
22-33 State Team Trials (Lower Light)  
30 Match Rifle (Lower Light)

**August**  
5-6 Yunta OPM (Yunta)

19-29 Whyalla OPM (Whyalla)  
26-27 Match Rifle Champs (Lower Light)

**September**  
10 Kapunda OPM (Kapunda)  
16-17 State Team Trials (Lower Light)  
23-24 Maitland OPM (Maitland)

**October**  
15 No.2 DRA OPM (Mt Barker)  
29 SARA AGM (Lower Light)  
29 East V West (Lower Light)

**November**  
25 Yunta Christmas shoot (Yunta)  
3 Match Rifle (Lower Light)

**VICTORIA**

**July**  
15-16 Warracknabeal PM (Warracknabeal)  
29 Pennant Reserve

**August**  
5-6 GVDRA & Karamomus PM (Karamomus)  
26 Pennant Reserve

**September**  
16 Wodonga LR Picnic shoot (Tallangatta)  
30 Pennant Reserve

**October**  
14-15 DRA Teams (Wellsford)  
14 VRA AGM  
28 Pennant Reserve

**November**  
25 Victoria Police Rifle Club 379 Centennial OPM (Wellsford)

**WESTERN AUSTRALIA**

**July**  
2 WARA Council Meeting & Annual Meeting of Council (Clubroom Pinjar)  
8-9 Carnarvon Rifle Club PM (Carnarvon)  
15-16 Meekatharra Rifle Club PM (Meekatharra)  
29-30 Chapman Valley Rifle Club PM (Chapman Valley)

**August**  
4 Geraldton Greenough RC PM (Greenough)  
5-6 North West DRA PM (Greenough)  
20 Billy Sing Interclub Service Sniper Competition (Pinjar)  
26-27 Metropolitan Prize Meeting (Pinjar)

**September**  
9-10 Central Wheat Belt DRA PM (Merredin)  
16-17 Northampton Rifle Club PM (Northampton)  
20 WA Veterans Championships (Pinjar)  
21 DRA Teams, Ray Miles Teams (Pinjar)  
22-23 Duke of Edinburgh & Queens PMs (Pinjar)  
24 WARA Annual General Meeting (Clubroom Pinjar)  
25 Queens PM (Pinjar)

**October**  
7-8 Dowerin Rifle Club PM (Dowerin)  
29 Corrigin Rifle Club PM (Corrigin)

**November**  
4-5 Busselton Service Rifle (Coolilup)  
12 WARA Council Meeting (Clubroom Pinjar)  
26 Boddington Rifle Club PM (Boddington)

**TASMANIA**

**September**  
30 TRA Short Range Prize Meeting 500/600/700 (Campbell Town)

**October**  
8 TRA Annual General Meeting (Campbell Town)

**November**  
4 Launceston VDC PM 500/500 600/600 (Campbell Town)  
25 Teams Match - Coached Pairs 500/600 (Campbell Town)

**December**  
9 Palmerston Club Teams (short range) 500/600/700 (Campbell Town)

**2018**

**January**  
13 North West Prize Meeting 500/500/600 (Sheffield)  
27 West Coast Prize Meeting 300/600/900 (Strahan)  
28 Strahan West Coast Prize Meeting 600/300 (Strahan)

**March**  
2 MR Practice from 1.00pm (Campbell Town)  
3 Tasmanian Match Rifle Champs 1000, 1100, 1200 (Campbell Town)  
4 Tasmanian Match Rifle Champs 1000, 1100, 1200 (Campbell Town)  
5 1500 Yards Championships 1,500 (Campbell Town)  
8 Llewellyn Series 500, 600, 700, 800 (Campbell Town)  
9 Llewellyn Series / 1000 Champs 900, 1000 : 1000 (Campbell Town)  
10 Tas Queens PM Stage 1 500, 500, 600, 600 (Campbell Town)  
11 Tas Queens PM Stage 2 700, 700, 800, 800 (Campbell Town)  
12 Tas Queens PM Stage 3 900, 1000 (Campbell Town)  
24 Sandford Prize Meeting 500/600/600 (Sandford)

**April**  
7 Campbell Town Prize Meeting 500/600/900/1000 (Campbell Town)  
28 Teams Match - Coached Pairs 900, 1000 (Campbell Town)

**May**  
12 Palmerston Club Teams (long range) 800/900/1000 (Campbell Town)  
26 TRA Long Range Prize Meeting 15 @ 900/1000 (Campbell Town)



"To promote and develop the sport of target shooting in Australia"

Australian Target Rifle Magazine welcomes contributions covering shooting events, topics of relevance to target shooting and technical articles. Submitting material is easy - just email some text to [atr\\_editorial@nraa.com.au](mailto:atr_editorial@nraa.com.au)

**Queens Series 2017**

August 15-19 ..... QRA Queens  
September 13-17 ..... NSW Queens  
September 22-25 ..... WA Queens  
November 15-19 ..... ACT Queens

# Aussies in South Africa

Photographs by Donna Negus



# Faces of the Victorian Queens

Photographs by Ken Reither, Peter Farley and Robyn Jackman



## The Under 25 Team: Winners of the Australia Match

Photograph by Donna Negus



Team: Australia U25				Competition					
Capt: [Name]									
Manager: [Name]									
Shooter	Coach	Shots	Scoring Shots	Score	Distance	300	400	500	Grand Total
1	[Name]	[Shots]	[Scoring Shots]	[Score]	[Distance]	[300]	[400]	[500]	[Grand Total]
2	[Name]	[Shots]	[Scoring Shots]	[Score]	[Distance]	[300]	[400]	[500]	[Grand Total]
3	[Name]	[Shots]	[Scoring Shots]	[Score]	[Distance]	[300]	[400]	[500]	[Grand Total]
4	[Name]	[Shots]	[Scoring Shots]	[Score]	[Distance]	[300]	[400]	[500]	[Grand Total]
5	[Name]	[Shots]	[Scoring Shots]	[Score]	[Distance]	[300]	[400]	[500]	[Grand Total]
6	[Name]	[Shots]	[Scoring Shots]	[Score]	[Distance]	[300]	[400]	[500]	[Grand Total]
7	[Name]	[Shots]	[Scoring Shots]	[Score]	[Distance]	[300]	[400]	[500]	[Grand Total]
8	[Name]	[Shots]	[Scoring Shots]	[Score]	[Distance]	[300]	[400]	[500]	[Grand Total]